



SURGICAL INSTRUMENTS SETS CATALOGUE

About Us – Aramid Industries, Brenner Import & Export Company & UK Office

Aramid Industries, Brenner Import & Export Company China, and our UK office Brenner Import and Export company UK Ltd are united by a single vision: to deliver excellence in manufacturing and global trade. With strong operational bases in Pakistan, China, and the United Kingdom, we bring precision, quality, and innovation to the surgical, medical, and cosmetic instrument industry—backed by seamless international reach.

Aramid Industries – Excellence in Manufacturing

Located in Sialkot, Pakistan—a world-renowned hub for surgical and medical instruments—Aramid Industries is equipped with state-of-the-art technology and a highly skilled workforce. We specialize in producing world-class:

- Surgical Instruments
- Dental Instruments
- Orthopedic Instruments
- Electro Surgical Instruments
- Veterinary Instruments
- Hospital Textiles
- Beauty Instruments

With over fifteen years of expertise, we maintain the highest international standards to ensure unmatched craftsmanship, durability, and performance.

Through ongoing research and development, we create innovative, user-friendly, and high-performance instruments to meet the evolving needs of healthcare and cosmetic professionals worldwide. We also offer custom manufacturing and in-house repair services, making us a reliable one-stop partner for our clients. Brenner Import & Export Company – Your Global Trade Partner in China

Operating from Guangzhou and Shanghai, China, Brenner Import & Export Company serves as the international trading arm of Aramid Industries. We specialize in catering to the Chinese domestic market while managing exports worldwide.

Our strong presence in China allows us to:

- Provide seamless supply chain solutions
- Ensure smooth customs clearance and regulatory compliance
- Conduct thorough quality inspections
- Offer competitive pricing and personalized customer service

From small distributors to large medical institutions, we ensure hassle-free and reliable trade services, strengthening long-term relationships with global buyers and distributors.

Brenner Import & Export Company UK – Expanding Our Global Reach

Our UK office adds a powerful dimension to our global operations, serving as a strategic hub for Europe and beyond. Based in London, it enables us to:

Connect directly with European buyers and distributors

Ensure compliance with EU and UK medical device regulations

Provide faster and more efficient customer support for European clients

Strengthen our presence in international exhibitions and partnerships

With the UK office, we now bridge Asia and Europe seamlessly, giving our partners confidence in working with a company that truly understands global trade dynamics.

Why Choose Us?

- ✓ Uncompromised Quality – Internationally certified products manufactured with precision
- ✓ End-to-End Solutions – From production to export, we manage the entire process
- ✓ Research & Innovation – Constant investment in advanced technologies
- ✓ Custom Manufacturing & Repairs – Tailored solutions for unique needs
- ✓ Global Reach – Strong presence in Pakistan, China, and the UK for international coverage

At Aramid Industries and Brenner Import & Export Company, our commitment goes beyond manufacturing and trade. We aim to provide world-class instruments with unmatched service and global accessibility. Whether you require top-quality instruments for your medical practice or a trustworthy partner for worldwide trade, we are your one-stop solution.

Management Team

Aramid Industries & Brenner Import and Export Company

At Aramid Industries and Brenner Import & Export Company, our success is driven by visionary leadership, global expertise, and a commitment to excellence at every level. Our management team brings together decades of experience in manufacturing, international trade, finance, quality assurance, and global logistics — ensuring that our clients receive the finest surgical, dental, and cosmetic instruments with seamless service worldwide.

Executive Leadership

Mr. Ahmed Hussain

Founder & Chief Executive Officer (CEO)

Guangzhou, China | Sialkot, Pakistan | London, United Kingdom

Ahmed Hussain is the driving force behind Aramid Industries and Brenner Import & Export Company. With over 15 years of experience in international manufacturing, trade, and brand development, he has built a global network connecting Asia, Europe, and Africa. His vision of combining Pakistani craftsmanship with Chinese efficiency and Western market standards has positioned the company among the leading global suppliers of surgical and cosmetic instruments.

“Our mission is simple — to deliver world-class quality with integrity, innovation, and commitment.”

Mr. Saad Zulfiqar

Director – Manufacturing & Quality Control

Based in Sialkot, Mr. Saad oversees all manufacturing operations, quality assurance, and process optimization at Aramid Industries. With deep expertise in stainless steel instrumentation, AQL standards, and ISO-compliant production, he ensures every product meets the highest benchmarks of durability and precision.

Mr. Burhan Asif

Director of Production & R&D (Pakistan Division)

Mr. Burhan leads the research and development initiatives at Aramid Industries, focusing on material innovation, ergonomic design, and advanced polishing technologies to enhance product performance and user safety.
Brenner Import & Export Company – China Operations

Ms. Pan Shao Ling

Director – International Trade & Client Relations (China)

Operating from Guangzhou, Ms. Shelly manages Chinese domestic sales and export coordination. With a decade of experience in international procurement, customs management, and client communication, she ensures that global customers receive timely, compliant, and quality-assured deliveries.

Mr. Bai Hongjun

Director – Supply Chain & Quality Inspection (China)

Mr. Bai oversees supplier evaluation, packaging standards, and export documentation to guarantee that every shipment aligns with client requirements and regulatory norms.

Brenner Import & Export Company – United Kingdom Office

Mrs. Maryam Ahmed

Director – European Operations & Compliance

Based in London, Mrs. Maryam is responsible for European client engagement, regulatory compliance, and market expansion strategies. She ensures that all products conform to EU MDR and UK MHRA standards, enabling smooth distribution and import into Europe.

Mr. Mustafa Sarfraz

Finance & Strategic Planning Manager (UK)

Mr. Sarfraz manages financial oversight, trade compliance, and strategic growth initiatives across the UK and EU regions. His role strengthens the company's financial integrity and international partnerships.

Advisory Board

Dr. Yahya (MD)

Medical Advisor – Product Development

A practicing surgeon and global advisor to the company, Dr. Yahya contributes his clinical insight to the design and testing of surgical instruments, ensuring they meet practical standards of performance and ergonomics.

Engr. Aziz

Technical Advisor – Process Optimization

With engineering expertise and decades of industrial experience, Engr. Aziz supports continuous improvement initiatives and modernization projects across the company's production facilities.

Our Team Philosophy

At Aramid Industries and Brenner Import & Export Company, leadership is more than management — it's a partnership built on trust, transparency, and teamwork. Every member of our global team contributes to a shared mission:

To create, innovate, and deliver instruments that enhance medical precision and improve lives worldwide.

Global Outreach – Aramid Industries & Brenner Import and Export Company

Aramid Industries and **Brenner Import & Export Company** have established a comprehensive global presence, connecting manufacturing excellence in Pakistan with advanced trade operations in China and a strategic gateway in the United Kingdom. Our integrated global network allows us to serve partners across North America, Europe, Africa, and Australia with precision, reliability, and consistent quality.

Through daily and formal exports to these regions, we have developed a dynamic understanding of international market trends, healthcare standards, and evolving product needs. This strong global footprint empowers our Research & Development Department to continuously analyze Western business trends, innovate new product lines, and modernize existing departments—ensuring that our instruments remain at the forefront of performance, safety, and user experience.

Exporting to Over 50 Countries

With a legacy of craftsmanship and innovation, **Aramid Industries** and **Brenner Import & Export Company** have become one of the most trusted and recognized names in the global surgical and dental instrument industry. Our products are exported to over 50 countries across:

Asia – Pakistan, China, Japan, South Korea, Malaysia, and the Middle East

Europe – United Kingdom, Germany, France, Italy, Spain, and Eastern Europe

North America – United States, Canada, and Mexico

Africa – South Africa, Egypt, Kenya, and Nigeria

Australia & Oceania – Australia, New Zealand, and surrounding markets

Our instruments are trusted by hospitals, clinics, distributors, and medical professionals worldwide, meeting and exceeding international standards of quality and precision.

A Global Network Rooted in Quality

Aramid Industries (Pakistan) – The manufacturing powerhouse, equipped with advanced facilities in Sialkot and a skilled workforce specializing in surgical, dental, orthopedic, and beauty instruments.

Brenner Import & Export Company (China) – The global trading hub operating from Guangzhou and Shanghai, managing logistics, compliance, and exports with efficiency.

Brenner Import & Export Company UK – The European gateway, ensuring compliance with UK and EU medical regulations, building partnerships, and facilitating smooth distribution across Europe.

Together, these entities form a synchronized global ecosystem that connects craftsmanship with commerce—offering high-quality medical and cosmetic instruments to customers around the world.
Our Global Commitment

- ✓ Worldwide Accessibility – Reliable shipping and daily exports to all major regions
- ✓ Compliance & Certification – ISO, CE, and relevant regulatory standards for all markets
- ✓ Customer-Centric Approach – Localized support and communication across time zones
- ✓ Innovation Through Global Insight – Continuous modernization inspired by international trends
- ✓ Partnership for Growth – Building long-term relationships with importers, distributors, and healthcare organizations

At Aramid Industries and Brenner Import & Export Company, our vision is to connect continents through quality,

PRODUCTION TOUR



Factory & Production Facilities

Welcome to our production heartland — where precision engineering and craftsmanship meet global standards. At Aramid Industries and Brenner Import & Export Company, our manufacturing facilities are designed for excellence, flexibility, and efficiency, enabling us to deliver premium surgical, dental, and cosmetic instruments worldwide.

Facilities & Locations

Sialkot, Pakistan — Our primary manufacturing hub. Equipped with forging, CNC machining, polishing, assembly, sterilization, and packaging units, all in one integrated campus.

Guangzhou & Shanghai, China — Secondary production, finishing, export packaging, and quality inspection centers, closely aligned with our trading operations.

United Kingdom Office (London) — Though not a production site, it provides regulatory oversight, quality assurance coordination, and European compliance support.

Production Capabilities & Departments

1. Forging & Initial Shaping

Hot forming and cold forging of blanks to create instrument profiles, while preserving material integrity and strength.

2. Precision Machining & Milling

CNC machining centers, Swiss-type lathes, and multi-axis machines for detailed cuts, threads, and structural features.

3. CNC Engraving & Laser Marking

High-resolution engraving of product codes, company logos, and measurement marks, with traceability and anti-counterfeit features.

4. Grinding, Polishing & Finishing

Surface refinement stations to produce mirror, satin, or micro-textured finishes, depending on product requirements.

5. Heat Treatment & Hardened Processes

Controlled tempering, quenching, and annealing to achieve desired hardness (e.g. optimal HRC for 304 / 410 / 420 stainless steel).

6. Passivation & Surface Treatment

Chemical or electrochemical passivation to enhance corrosion resistance, reduce free iron, and ensure biocompatibility.

7. Sterilization & Quality Inspection

Internal inspection labs for dimensional checks, metallurgical tests, and surface analysis. Instruments are inspected under clean environments before packaging.

8. Assembly & Set Packaging

Final set configuration, tray layout, labeling, and secure sterilizable packaging. Custom packaging (OEM) also handled in-house.

PRODUCTION TOUR



Machinery & Equipment Highlights

- CNC Swiss-type lathes for micromachining
- Multi-axis CNC machining centers (3/4/5 axis)
- CNC laser engraving and marking systems
- High-precision grinders and polishers
- Automated polishing stations with robots
- Ultrasonic cleaners and water-recycling passivation baths
- Cleanrooms or controlled environment finishing zones
- In-house tool & cutter manufacturing capability
- Quality, Traceability & Capacity

ISO / IEC 17025 Accredited Testing Lab — All measurements, hardness tests, metallurgical analysis, and surface inspections follow accredited protocols.

Integrated quality tracking from raw material through to packaging—every batch and instrument is serial-tracked.

Scalable capacity to manage small custom orders as well as bulk sets (hundreds of sets per month).

Flexible line balancing to prioritize urgent custom or repeat orders without disrupting standard production schedules.

Why Our Factory Stands Out

Vertical integration: We manufacture our own tools and cutters, giving us full control over precision and cost. Single-site efficiency in Pakistan: Holding most departments under one roof reduces lead times and improves communication.

Global alignment: Facilities in Pakistan and China synchronized to manage production, finishing, export packaging, and quality checks.

Compliance oriented: Our factory setups comply with ISO 9001, ISO 13485, ISO 14001, ISO 45001, and other relevant standards.

Sustainable design: Use of energy-efficient machinery, wastewater recycling systems, and waste metal recycling protocols.



Quality Control & Certifications

Aramid Industries & Brenner Import and Export Company

At Aramid Industries and Brenner Import & Export Company, quality is not a department — it is our culture. We are committed to delivering only the highest quality instruments and services, backed by precision engineering, rigorous inspection, and continuous innovation.

With a strong operational base in Pakistan, China, and the United Kingdom, our Quality Management System (QMS) integrates global best practices from EU MDR, U.S. FDA, and Chinese CFDA (NMPA) standards — ensuring every product we manufacture meets the most stringent international compliance requirements. Our Quality Philosophy

We believe that progress begins with precision.

Our culture promotes a constant cycle of learning, improvement, and innovation — empowering our people to challenge boundaries and set new industry standards.

By encouraging creativity and accountability, Aramid Industries and Brenner Import & Export Company continuously evolve to meet the future of global healthcare manufacturing.

“Deliver excellence, exceed expectations, and inspire trust — every single day.”

Ahmed Hussain, CEO

International Certifications & Regulatory Compliance

Aramid Industries and Brenner Import & Export Company operate under a unified, globally recognized QMS that ensures full traceability and compliance across every stage — from raw material sourcing to final dispatch.

We proudly hold the following international accreditations and certifications:

- ✓ European Authorized Representative (EC REP) Certificate
- ✓ EUDAMED SRN Registration under EU Medical Device Regulation (EU MDR 2017/745)
- ✓ *QMS Compliant with EU Medical Device Directive (EU MDD 93/42/EEC)
- ✓ *QMS Certified according to cGMP by the U.S. Food and Drug Administration (FDA)
- ✓ Registered with China Food and Drug Administration (CFDA / NMPA) for medical device trade and import approval in the Chinese market
- ✓ ISO 9001:2015 – Quality Management System
- ✓ ISO 13485:2016 – Medical Device Manufacturing Standard
- ✓ ISO 14001:2015 – Environmental Management System
- ✓ ISO 45001:2018 – Occupational Health and Safety Management System

All instruments are produced from AISI 304, 410, and 420 stainless steel, tested and certified in compliance with ISO, ASTM, and CE Mark requirements.

Further compliance includes:

ISO 7151, ISO 7153-1, ISO 11135, ISO 13402, ISO 17664, ISO 17664-1, ISO 21850-1, ISO 14971, ISO 15223-1, ISO 20417, ISO 11607-1, ASTM A380-06, ASTM F899-20, and EU REACH Regulation.

Our certifications reflect not only quality assurance but also safety, sustainability, and ethical responsibility across all production sites.

Capability & Innovation

We combine personalized craftsmanship with large-scale manufacturing efficiency, powered by cutting-edge R&D and automation systems.

Through strategic collaborations and in-house innovation, we develop customized solutions for hospitals, private brands, and international distributors — ensuring that every client's specific needs are met with precision.

Our integrated presence in Sialkot (Pakistan), Guangzhou & Shanghai (China), and London (UK) enables us to balance:

Technical expertise

Market access

Global compliance

Localized customer service

Quality Assurance Process

Every instrument undergoes a multi-stage quality control system to ensure unmatched performance, safety, and reliability.

01. Critical Dimensions

Each instrument is carefully evaluated to ensure it performs flawlessly during critical surgical procedures. Functional accuracy, balance, and smooth operation are verified under simulated use conditions.

02. Surface Inspection

Every surface is inspected under magnification to detect and eliminate imperfections, discolorations, or contaminants. Instruments must have a uniform satin or mirror finish, free from stains, pits, or residues.

03. Dimensional Verification

Using calipers, micrometers, laser measurement tools, and master templates, all dimensions are verified against engineering drawings for pattern consistency and precision tolerance.

Continuous Improvement

Our Quality Assurance and R&D divisions work in collaboration with surgeons, dentists, and medical technicians worldwide to constantly enhance performance and ergonomics.

Feedback loops from global clients are analyzed to upgrade designs, improve materials, and integrate emerging technologies such as AI-assisted inspection, CNC precision machining, and plasma passivation systems.

We maintain full traceability and documentation from steel selection to packaging, ensuring every product can be traced through its entire production lifecycle.

Our Promise

Uncompromised Quality – Certified and inspected under ISO, FDA, EU, and CFDA standards.

Total Compliance – Globally approved manufacturing, labeling, and documentation systems.

Sustainable Manufacturing – Environmentally responsible and worker-safety certified facilities.

Customer Confidence – Every product is a symbol of trust, precision, and performance.

At Aramid Industries and Brenner Import & Export Company, quality is not maintained — it is continually perfected.

Our goal is to bridge continents through craftsmanship, compliance, and credibility.

Warranty & Quality Assurance

Aramid Industries (Pakistan) and Guangzhou Brenner Import & Export Co., Ltd. (China) are committed to delivering premium-quality surgical instruments. Aramid Industries, our ISO-certified manufacturing unit in Pakistan, ensures the highest level of craftsmanship, while Guangzhou Brenner, our trading company in China, guarantees efficient distribution and customer service.

We stand behind our products with a comprehensive warranty against any manufacturing or material defects. If any defect is identified, we will repair or replace the instrument at no additional cost to the customer.

Corrective & Preventive Actions

At Aramid Industries & Guangzhou Brenner, we prioritize continuous quality improvement and product safety through a rigorous corrective and preventive action (CAPA) system: Systematic Investigation: Thorough analysis of any reported issues to eliminate root causes and prevent recurrence. Process Optimization: Regular evaluation and enhancement of manufacturing and quality control procedures to ensure compliance with global standards. Risk Management: Proactive identification of potential risks and preventive measures to ensure product reliability and safety. Our dedication to excellence and innovation drives us to maintain world-class manufacturing and distribution standards.

Custom Manufacturing

We specialize in custom manufacturing and can produce bespoke surgical instruments according to your exact specifications and design requirements. Whether you need modifications to existing products or entirely new instruments, our expert engineers and precision manufacturing processes ensure top-tier results.

We welcome inquiries for customized medical instruments that are not listed in our catalog.

Delivery Timeline

Our standard production and delivery time is 60 days from the receipt of a confirmed purchase order. We ensure timely delivery while maintaining the highest quality standards.

Pricing & Terms

At Aramid Industries & Guangzhou Brenner, we offer high-quality surgical instruments at competitive prices with full transparency: Prices in USD: All prices are quoted in US dollars and are subject to applicable fees, taxes, and other charges, including environmental handling fees and shipping costs. Fair & Flexible Pricing: We continuously optimize our pricing structure to ensure affordability without compromising quality.

Custom Pricing for Bulk Orders: We offer special pricing and long-term supply agreements for bulk buyers and distributors. For personalized quotes or volume discounts, please contact us.

Product Liability & Usage Guidelines

We ensure that all instruments produced by Aramid Industries meet exceptional quality standards. However, we do not accept liability for: Instruments that have been altered or modified from their original state. Any failure or damage resulting from improper use, not aligned with the intended medical application. Proper handling, sterilization, and compliance with manufacturer guidelines are essential to maintaining product integrity and ensuring patient safety.

For inquiries, bulk orders, or partnership opportunities, please contact us at:

Aramid Industries (Pakistan) – Manufacturing Unit

Guangzhou Brenner Import & Export Co., Ltd. (China) – Trading Company

Precision. Quality. Innovation.

SR #	DESCRIPTION	CATALOGUE CODE	CATEGORY
1	Abdominal Hysterectomy Instruments Set	GBAI-1001	General & Major Surgery Sets
2	Cesarean Section Surgical Instrument Set	GBAI-1015	General & Major Surgery Sets
3	Appendectomy Surgical Instrument Set	GBAI-1005	General & Major Surgery Sets
4	Major Basic Surgical Instrument Set	GBAI-1034	General & Major Surgery Sets
5	General Surgery Instruments Set	GBAI-1025	General & Major Surgery Sets
6	Laparotomy Pediatric Instruments Set	GBAI-1031	General & Major Surgery Sets
7	Laparotomy Emergency Set	GBAI-1057	General & Major Surgery Sets
8	Amputation Surgical Instrument Set	GBAI-1004	General & Major Surgery Sets
9	Dressing Set Instruments	GBAI-1020	General & Major Surgery Sets
10	Minor Basic Instrument Set	GBAI-1037	General & Major Surgery Sets
11	Gynecology Instruments Set	GBAI-1026	Gynecology & Obstetrics
12	C-Section Set	GBAI-1059	Gynecology & Obstetrics
13	IUD Insertion Set	GBAI-1061	Gynecology & Obstetrics
14	D & C Set (Dilation and Curettage Instrument Set)	GBAI-1003	Gynecology & Obstetrics
15	ACL PCL Instrument Set	GBAI-1079	Orthopedic & Trauma Surgery
16	Basic Orthopedic Instrument Set	GBAI-1010	Orthopedic & Trauma Surgery
17	Broken Screw Removal Set	GBAI-1014	Orthopedic & Trauma Surgery
18	DHS DCS Instrument Set	GBAI-1018	Orthopedic & Trauma Surgery
19	Elastic Nail Instrument Set	GBAI-1021	Orthopedic & Trauma Surgery
20	Femur Nail Instrument Set	GBAI-1023	Orthopedic & Trauma Surgery
21	Gamma Nail Instrument Set	GBAI-1024	Orthopedic & Trauma Surgery
22	Humras Nail / Tibia Interlocking Nail Instrument Set	GBAI-1028	Orthopedic & Trauma Surgery
23	Interlocking Nail Instrument Set	GBAI-1029	Orthopedic & Trauma Surgery
24	Large Fragment Set	GBAI-1032	Orthopedic & Trauma Surgery
25	Small Fragment Set	GBAI-1043	Orthopedic & Trauma Surgery
26	Orthopedic Instruments Set (Bone Surgery Set)	GBAI-1040	Orthopedic & Trauma Surgery
27	Minor Orthopedic Instrument Set	GBAI-1038	Orthopedic & Trauma Surgery
28	Tibia Nail Instruments Set	GBAI-1050	Orthopedic & Trauma Surgery
29	Orthopedic Implant Instrument Set	GBAI-1074	Orthopedic & Trauma Surgery
30	Emergency Trauma Instrument Set	GBAI-1076	Orthopedic & Trauma Surgery
31	Anterior Cervical Discectomy & Fusion Set (ACDF)	GBAI-1002	Neurosurgery & Spine
32	Neurosurgery Set	GBAI-1039	Neurosurgery & Spine
33	Spinal Surgery Instruments Set	GBAI-1044	Neurosurgery & Spine
34	Craniotomy Basic Surgery Set	GBAI-1063	Neurosurgery & Spine
35	Leyla Retractor Set	GBAI-1069	Neurosurgery & Spine
36	Basic ENT Instrument Set	GBAI-1009	ENT / Head & Neck
37	ENT Sinus Tonsil Set	GBAI-1056	ENT / Head & Neck
38	Tracheotomy Set	GBAI-1051	ENT / Head & Neck
39	Thyroidectomy Instruments Set	GBAI-1049	ENT / Head & Neck
40	Intubation Set	GBAI-1030	ENT / Head & Neck
41	Blepharoplasty Instrument Set	GBAI-1013	Ophthalmic & Microsurgery
42	Microsurgical Instruments Set	GBAI-1035	Ophthalmic & Microsurgery
43	Micro Vascular Surgery Set	GBAI-1060	Ophthalmic & Microsurgery
44	Ophthalmic Surgery Set	GBAI-1078	Ophthalmic & Microsurgery
45	Dental Examination Set	GBAI-1016	Dental & Oral Surgery
46	Dental Suture Practice Kit	GBAI-1017	Dental & Oral Surgery
47	Dental Surgery Set	GBAI-1019	Dental & Oral Surgery

SR #	DESCRIPTION	CATALOGUE CODE	CATEGORY
48	Extraction Forceps & Elevators	GBAI-1022	Dental & Oral Surgery
49	Periodontal Surgery Kit	GBAI-1041	Dental & Oral Surgery
50	Home Dental Kit	GBAI-1027	Dental & Oral Surgery
51	Dental & Oral Surgery Set	GBAI-1075	Dental & Oral Surgery
52	Av Fistula Instrument Set	GBAI-1007	Cardiothoracic & Vascular
53	Thoracotomy Instrument Set	GBAI-1048	Cardiothoracic & Vascular
54	Vascular Surgery Instruments Set	GBAI-1053	Cardiothoracic & Vascular
55	Vasectomy Instrument Set	GBAI-1054	Cardiothoracic & Vascular
56	Cardiac Vascular Surgery Set	GBAI-1058	Cardiothoracic & Vascular
57	Cardiovascular Surgery Set	GBAI-1072	Cardiothoracic & Vascular
58	Bakes Dilator Set	GBAI-1008	Cardiothoracic & Vascular
59	Urethral Sound Kit	GBAI-1052	Cardiothoracic & Vascular
60	Urology Open Surgery Set	GBAI-1062	Cardiothoracic & Vascular
61	Balfour Abdominal Set	GBAI-1064	Retractor Systems
62	Balfour Abdominal Retractor Set	GBAI-1067	Retractor Systems
63	Modular Abdominal Wall Retractor(Frame + Blades)	GBAI-1066	Retractor Systems
64	Circular Ring (Bookwalter-type) Retractor System	GBAI-1068	Retractor Systems
65	Bookwalter Retractor Set	GBAI-1070	Retractor Systems
66	Basic Plastic Surgery Instrument Set	GBAI-1011	Hand & Plastic / Reconstructive
67	Hand Surgery Instrument Set	GBAI-1065	Hand & Plastic / Reconstructive
68	Plastic & Reconstructive Surgery Set	GBAI-1073	Hand & Plastic / Reconstructive
69	Littauer Suture Removal Scissors	GBAI-1033	Minor, Suture & Extraction Kits
70	Surgical Extraction Kit	GBAI-1045	Minor, Suture & Extraction Kits
71	Surgical Suture Removal Kit	GBAI-1046	Minor, Suture & Extraction Kits
72	Suture Removal Set	GBAI-1047	Minor, Suture & Extraction Kits
73	Military Suture Kit	GBAI-1036	Minor, Suture & Extraction Kits
74	Laparoscopy Basic Instrument Set	GBAI-1071	Laparoscopy & Endoscopy
75	Pediatric Surgery Set	GBAI-1077	Pediatric & Veterinary
76	Veterinary Surgical Kit	GBAI-1055	Pediatric & Veterinary
77	Post-mortem Instrument Set	GBAI-1042	Miscellaneous
78	Bipolar Instrument Set	GBAI-1012	Miscellaneous
79	Arthroscopy Instrument Set	GBAI-1006	Miscellaneous
80	Medical Student Practice Set 1	GBAI-1080	Student Training Sets
81	Medical Student Practice Set 2	GBAI-1081	Student Training Sets
82	Medical Student Practice Set 3	GBAI-1082	Student Training Sets
83	Student Mini Set	GBAI-1083	Student Training Sets
84	Dental Set 1	GBAI-1084	Dental Instruments
85	Dental Implant Set	GBAI-1085	Implantology
86	Oral Surgery / Implant Set	GBAI-1086	Oral Surgery & Implantology
87	Dental Composite / Restorative Set	GBAI-1087	Restorative Dentistry
88	Dental Restorative Set	GBAI-1088	Restorative Dentistry
89	Dental Examination Kit	GBAI-1089	Diagnostic Dentistry
90	Adult Dental Extraction Forcep Set	GBAI-1090	Extraction Instruments
91	Child Extraction Forcep Set	GBAI-1091	Pediatric Dentistry
92	Root Elevator Set	GBAI-1092	Extraction & Elevation Instruments
93	Orthodontic Set	GBAI-1093	Orthodontics



**ABDOMINAL HYSTERECTOMY
INSTRUMENTS SET (GBAI-1001)**

Sr. #	Code	Instrument Description	Specification	Type	Steel Type	Finish	QTY
01	BF120R	Foerster Sponge Forceps Straight	24 cm	Straight	AISI 410 / 420	Satin / Mirror Polish	2
02	EA097R	Allis Tissue Forceps 5x6 Teeth	24 cm	Straight	AISI 420A / 420B	Mirror Polish	2
03	BJ058R	Mixter Rt Angle Forceps	24 cm	Right Angle	AISI 420 / 410	Satin Finish	2
04	BH963R	Schmidt Curved Hemostat	18 cm	Curved	AISI 420 / 410	Satin / Sand-Blasted	2
05	BM259R	Heaney Needle Holders	20 cm	Straight	AISI 410 + Tungsten Carbide (TC) Jaws	Satin Finish	2
06	MB906R	Heaney Clamps	18 cm	Straight	AISI 410	Satin Finish	6
07	BJ530R	Heaney-Ballentine Clamps	18 cm	Straight	AISI 410	Satin Finish	2
08	BJ522R	Heaney-Ballentine Clamps	18 cm	Curved	AISI 410	Satin / Sand-Blasted Teeth	1
09	BH446R	Rochester-Ochsner Forceps	18 cm	Straight	AISI 420A	Mirror Polish	8
10	BC602R	Metzenbaum Scissors	18 cm	Curved	AISI 420 / 420J2	Satin Finish	1
11	BC547R	Mayo Dissecting Scissors	18 cm	Curved	AISI 420 / 440A	Mirror Polish	1
12	BH447R	Rochester-Ochsner Forceps	18 cm	Curved	AISI 420A	Mirror Polish	4
13	BD755R	Russian Tissue Forceps	18 cm	-	AISI 410 / 420	Mirror Polish	1
14	FB400R	DeBakey Tissue Forceps	18 cm	-	AISI 420 / 420J2	Satin Finish	1
15	BB074R	Scalpel Handle	18 cm	-	AISI 410 / 420	Mirror Polish	1
16	BT601R	Deaver Retractor	18 cm	-	AISI 420 / 304	Mirror Polish	1
17	BT602R	Deaver Retractor	18 cm	-	AISI 420 / 304	Mirror Polish	1
18	BT613R	Deaver Retractor	18 cm	-	AISI 420 / 304	Mirror Polish	1
						TOTAL QUANTITY	39



Cesarean section surgical instrument set-(GBAI-1015)

Sr. #	Code	Instrument Description	Specification	Type	Steel Type	Finish	QTY
01	GBAI1015-01	Allis Tissue Forceps 4x5 Teeth	5 cm	STRAIGHT	AISI 304	Mirror Polish	4
02	GBAI1015-02	Knife Handle No 3	----	-	AISI 420 / 420J2	Mirror Polish	1
03	GBAI1015-03	Yankauer Suction Tube 20 Fr Standard	51 cm (20 Fr)	-	AISI 410 / 440A	Mirror Polish	1
04	GBAI1015-04	Sponge Bowl Capacity 1200 ml	— (capacity 1200 ml)	STRAIGHT	AISI 304 / 316L	Mirror Polish	1
05	GBAI1015-05	Sponge Bowl	12.5 × 6 cm	CURVED	AISI 304 / 316L	Mirror Polish	1
06	GBAI1015-06	Rochester Ochsner Forceps	20 cm	STRAIGHT	AISI 304 / 316L	Mirror Polish	1
07	GBAI1015-07	Rochester Ochsner Forceps	20 cm	CURVED	AISI 410 / 420	Satin Finish	1
08	GBAI1015-08	Metzenbaum Dissecting Scissors Standard	18 cm	CURVED	AISI 410 / 420	Satin Finish	1
09	GBAI1015-09	Mayo Hegar Needle Holder	15 CM	CURVED	AISI 410 / 420	Mirror Polish	1
10	GBAI1015-10	Mayo Hegar Needle Holder	20 cm	STRAIGHT	AISI 410 / 420	Mirror Polish	2
11	GBAI1015-11	Mayo Dissecting Scissors	17 cm	-	AISI 410 / 420	Mirror Polish	2
12	GBAI1015-12	Mayo Dissecting Scissors	17 cm	-	AISI 410 / 420	Satin Finish	2
13	GBAI1015-13	Luer Rongeur Single Action	-----	CURVED	AISI 410 / 420	Mirror Polish	1
14	GBAI1015-14	Babcock Intestinal Forceps	16 cm	-	AISI 410 / 420	Mirror Polish	1
15	GBAI1015-15	Kidney / Emesis Basin	20.5 × 10.8 × 4 cm	-	AISI 410 / 420	Mirror Polish	1
16	GBAI1015-16	Iodine / Solution Cup	8.3 × 5.1 cm	-	AISI 304 / 316L	Mirror Polish	2
17	GBAI1015-17	Alm Retractor 4x4 Teeth, Blunt	24 cm	-	AISI 304 / 316L	Mirror Polish	1
18	GBAI1015-18	Mixer Forceps Right Angle	24 cm	-	AISI 420 / 440A	Mirror Polish	2
19	GBAI1015-19	Dressing Forceps Serrated	14 cm	-	AISI 420 / 440A	Mirror Polish	6
20	GBAI1015-20	Dressing Forceps Serrated	20 cm	-	AISI 420A	Satin Finish	2
21	GBAI1015-21	Knife Rochester-Pean Forcep	23 cm	CURVED	AISI 304 / 316L	Mirror Polish	2
22	GBAI1015-22	Crile Hemostatic Forceps	14 cm	-	AISI 410 / 420	Satin Finish	2
23	GBAI1015-23	Crile Hemostatic Forceps	14 cm	-	AISI 410 / 420	Mirror Polish	1
24	GBAI1015-24	Braun Episotomy Scissors Angular	14 cm	-	AISI 420 / 420J2	Mirror Polish	12
25	GBAI1015-25	Baby Farabeuf Retractor Double Ended (Set of Two)	12 cm	-	AISI 420 / 420J2	Mirror Polish	2
26	GBAI1015-26	Backhaus Towel Clamp	13 cm	-	AISI 410 / 420	Mirror Polish	4
						TOTAL QUANTITY	61



Appendectomy Surgical Instrument Set (GBAI-1005)

Sr. #	Code	Instrument Description	Specification	Type	Steel Type	Finish	QTY
01	GBAI-1005-01	Mayo Scissors TC	14 CM	STRAIGHT	AISI 410 + Tungsten Carbide (TC) Inserts	Satin Finish (TC Edges)	1
02	GBAI-1005-02	Mayo Scissors TC	14 CM	CURVED	AISI 410 + Tungsten (TC) Inserts	Satin Finish (TC Edges)	1
03	GBAI-1005-03	Metzenbaum Scissors Curved	18 CM	CURVED	AISI 420 / 440A	Mirror Polish	1
04	GBAI-1005-04	Metzenbaum Scissors TC	18 CM	STRAIGHT	AISI 410 + Tungsten Carbide (TC) Inserts	Satin Finish (TC Edges)	1
05	GBAI-1005-05	Scalpel Handle	#4	-	AISI 410 / 420	Mirror Polish	2
06	GBAI-1005-06	Allis Tissue Forceps	15 CM	-	AISI 410A / 420B	Mirror Polish	2
07	GBAI-1005-07	Mcindoe Forceps	15 CM	-	AISI 410 / 420	Satin Finish	1
08	GBAI-1005-08	Kocher Tissue Forceps 1:2	16 CM	-	AISI 410	Satin Finish	4
09	GBAI-1005-09	Babcock Tissue Forceps	16 CM	-	AISI 410A / 420B	Mirror Polish	2
10	GBAI-1005-10	Mayo Hagar Needle Holder	11 CM	-	AISI 410 + Tungsten Carbide	Satin Finish (TC Jaws)	2
11	GBAI-1005-11	Backhaus Towel Clamps	25 CM	-	AISI 420 / 440A	Mirror Polish	4
12	GBAI-1005-12	Sponge Holding Forceps	14 CM	STRAIGHT	AISI 420 / 440A	Mirror Polish	2
13	GBAI-1005-13	Crile Forcep	14 CM	CURVED	AISI 410 / 420	Satin Finish	8
14	GBAI-1005-14	Crile Forcep	18 CM	STRAIGHT	AISI 420 / 420	Satin Finish	6
15	GBAI-1005-15	Spencer Wells	18 CM	STRAIGHT	AISI 410 / 420	Satin Finish	6
16	GBAI-1005-16	Spencer Wells	21 CM	CURVED	AISI 410 / 420	Satin Finish	8
17	GBAI-1005-17	US Army Retractor	18 CM	-	AISI 420 / 420	Satin Finish	2
18	GBAI-1005-18	Lane Forceps	15 CM	-	AISI 410 / 420	Mirror Polish	2
19	GBAI-1005-19	Adson Forceps	12 CM	-	AISI 410 / 420	Mirror Polish	2
20	GBAI-1005-20	Adson Forceps 1:2	12 CM	-	AISI 410 / 420	Mirror Polish	2
21	GBAI-1005-21	Forceps	16 CM	-	AISI 410 / 420	Mirror Polish	2
22	GBAI-1005-22	Gallipots	-	-	AISI 410 / 420	Mirror Polish	4
23	GBAI-1005-23	Kidney Dish	20 CM	-	AISI 304	Mirror Polish	2
						TOTAL QUANTITY	73



Major Basic Surgical Instrument Set-(GBAI-1034)

Sr. #	Code	Instrument Description	Specification	Type	Steel Type	Finish	QTY
01	GBAI1034-01	Backhaus Towel Forceps	13 cm (5½")	Straight	AISI 410	Satin	6
02	GBAI1034-02	Scalpel Handle (No. 3 & No. 4 Mix)	-----	Straight	AISI 420	Mirror	10
03	GBAI1034-03	Foerster Sponge Forceps (Serrated Jaws)	24 cm (9½")	Straight	AISI 410	Satin	3
04	GBAI1034-04	Allis TC-Edge Metzenbaum Scissors (Fine Tip)	18 cm (7")	Curved	AISI 420	Mirror	1
05	GBAI1034-05	TC-Edge Metzenbaum Scissors	17 cm (6¾")cm	Straight	AISI 410	Satin	2
06	GBAI1034-06	Surgical Scissors (Operating Type)	14 cm (5½")	Straight	AISI 410	Satin	4
07	GBAI1034-07	TC Universal Wire Cutting Scissors	15 cm (6")	Straight	AISI 420	Satin	1
08	GBAI1034-08	Pediatric Deaver Retractor	14 cm (5½")	Curved	AISI 420	Mirror	8
09	GBAI1034-09	Mixer Forceps Right Angle	9 cm (3½")	Straight	AISI 410	Mirror	1
10	GBAI1034-10	Joseph Double Prong Skin Hook	14 cm (5½")	Straight	AISI 410	Satin	4
11	GBAI1034-11	Joseph Double Prong Single Hook	16 cm (6¼")	Straight	AISI 420	Satin	1
12	GBAI1034-12	Ferguson Frazier Suction Tube	16 cm (6¼")	Curved	AISI 420	Satin	12
13	GBAI1034-13	Senn-Miller Retractor (3-Prong Sharp)	14 cm (5½")	Curved	AISI 410	Satin	12
14	GBAI1034-14	Weitlaner Retractor (2x3 Teeth, Blunt)	12.5 cm (5")	Curved	AISI 410	Satin	1
15	GBAI1034-15	Scissors (Straight, Sharp Tips)	20 cm (8")	Straight	AISI 420	Satin	1
16	GBAI1034-16	Jansen Mastoid Retractor 3x3 Teeth	20 cm (6¼")	Curved Blade	AISI 410	Satin	3
17	GBAI1034-17	Rochester Ochsner Forceps	21 cm (8¼")	Curved / Rake Type	AISI 410	Satin	2
18	GBAI1034-18	Foerster Sponge Forceps (Serrated Jaws)	14 cm (5½")	Curved	AISI 410	Satin	1
19	GBAI1034-19	Cushing Vein Retractor	20 cm (8")	Curved	AISI 410	Satin	1
20	GBAI1034-20	U.S. Army Retractor (Double Ended)	21.5 cm (8½")	Double-Ended	AISI 304	Polished	1
21	GBAI1034-21	Ribbon Retractor (Malleable)	33 x 2.5 cm (13" x 1")	Malleable	AISI 304	Polished	2
22	GBAI1034-22	Grooved Director (Probe End)	15 cm (6")	Curved	AISI 304	Polished	10
23	GBAI1034-23	Balfour Abdominal Retractor	18 cm (7")	Self-Retaining	AISI 304	Polished	1
24	GBAI1034-24	Probe with Eye		Straight	AISI 304	Polished	10
25	GBAI1034-01	Yankauer Suction Tube (Stainless Steel)	28 cm (11")	Curved	AISI 410	Satin	2
26	GBAI1034-02	Deschamps Ligature Needle	20 cm (8")	Curved (Right/Left)	AISI 420	Mirror	2
27	GBAI1034-03	TC Mayo-Hegar Needle Holder	20 cm (8")	Straight	AISI 410 AND TC	Satin	2
TOTAL QUANTITY							104

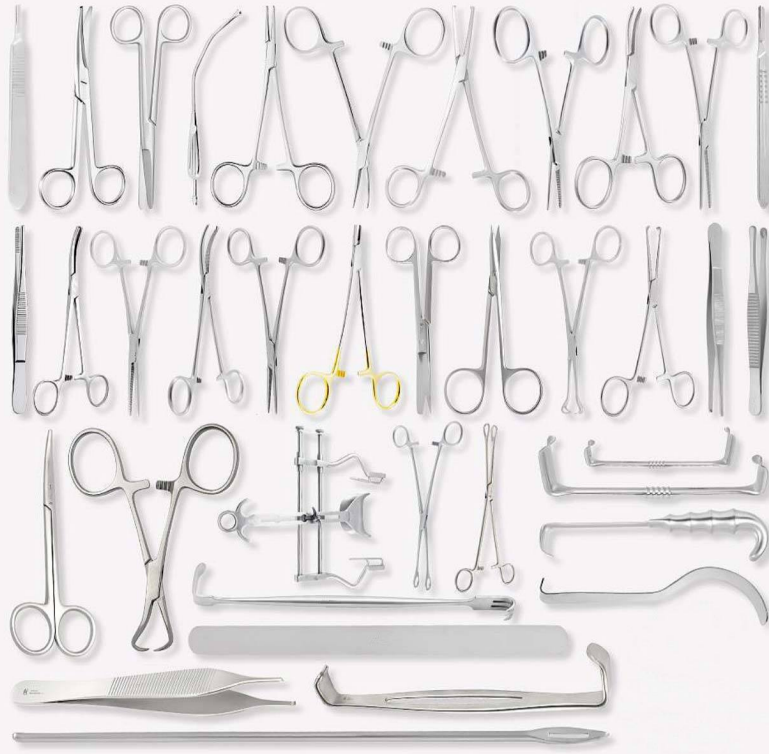

General Surgery Instruments Set-(GBAI-1025)

Sr. #	Code	Instrument Description	Specification	Type	Steel Type	Finish	QTY
01	GBAI1025-01	Scalpel Handle No.3	-----	Straight	AISI 410	Mirror Polish	2
02	GBAI1025-02	Scalpel Handle No.4	-----	Straight	AISI 410	Mirror Polish	2
03	GBAI1025-03	Metal Ruler	15 cm (6")	Straight	AISI 410	Satin Finish	1
04	GBAI1025-04	Mayo Dissecting Scissors	14 cm (5½")	Straight	AISI 420 / 420J2	Mirror Polish	2
05	GBAI1025-05	Mayo Dissecting Scissors	15 cm (5½")	Curved	AISI 410	Mirror Polish	1
06	GBAI1025-06	Yankauer Suction Tube (Stainless)	-----	Straight	AISI 420 / 420J2	Mirror Polish	2
07	GBAI1025-07	Halsted Mosquito Forceps	12.5 cm (5")	Straight	AISI 410	Mirror Polish	2
08	GBAI1025-08	Halsted Mosquito Forceps	12.5 cm (5")	Curved	AISI 410	Mirror Polish	6
09	GBAI1025-09	Mixter Forceps Right Angle	9 cm (3½")	Straight	AISI 410	Mirror Polish	6
10	GBAI1025-10	Kelly Forceps	9 cm (3½")	Curved	AISI 410	Mirror Polish	3
11	GBAI1025-11	Kelly Forceps	16 cm (6¼")	Straight	AISI 410	Mirror Polish	3
12	GBAI1025-12	Rochester-Pean Forceps	16 cm (6¼")	Straight	AISI 410	Mirror Polish	6
13	GBAI1025-13	Rochester-Pean Forceps	20 cm (8")	Curved	AISI 410	Mirror Polish	3
14	GBAI1025-14	Dressing Forceps	20 cm (8")	Curved	AISI 410	Mirror Polish	6
15	GBAI1025-15	Rochester Ochsner Forceps	16 cm (6¼")	Curved	AISI 410	Mirror Polish	3
16	GBAI1025-16	Rochester Ochsner Forceps	16 cm (6¼")	Straight	AISI 410	Mirror Polish	2
17	GBAI1025-17	Rochester Ochsner Forceps	20 cm (8")	Curved	AISI 410	Mirror Polish	2
18	GBAI1025-18	Dressing Forceps	14 cm (5½")	Straight	AISI 410	Mirror Polish	2
19	GBAI1025-19	Dressing Forceps	20 cm (8")	Curved	AISI 410	Mirror Polish	2
20	GBAI1025-20	Crile Hemostatic Forceps	14 cm (5½")	Straight	AISI 410	Mirror Polish	2
21	GBAI1025-21	Crile Hemostatic Forceps	14 cm (5½")	Straight	AISI 410	Mirror Polish	2
22	GBAI1025-22	Russian Tissue Forceps	20 cm (8")	Straight	AISI 410	Mirror Polish	12
23	GBAI1025-23	Tissue Forceps 1×2 Teeth	14 cm (5½")	Straight	AISI 410	Mirror Polish	12
24	GBAI1025-24	Tissue Forceps 1×2 Teeth	20 cm (8")	Straight	AISI 410 / Tungsten Carbide Inserts	Mirror Polish / Gold Handles (TC)	1

General Surgery Instruments Set-(GBAI-1025)

Sr. #	Code	Instrument Description	Specification	Type	Steel Type	Finish	QTY
25	GBAI1025-25	TC Mayo Hegar Needle Holder Serrated	15 cm (6")	Straight	AISI 410 / Tungsten Carbide Inserts	Mirror Polish / Gold Handles (TC)	2
26	GBAI1025-26	TC Mayo Hegar Needle Holder Serrated	18 cm (7")	Straight	AISI 410	Mirror Polish	2
27	GBAI1025-27	Lite Operating Scissors S/B	14 cm (5½")	Straight	AISI 410	Mirror Polish	2
28	GBAI1025-28	Lite Operating Scissors S/B	14 cm (5½")	Straight	AISI 410	Satin Finish	2
29	GBAI1025-29	Lister Bandage Scissors	11 cm (4¼")	Curved	AISI 410	Mirror Polish	1
30	GBAI1025-30	Liston Bone Forceps Angled	15 cm (6")	Straight	AISI 410	Mirror Polish	2
31	GBAI1025-31	Beyer Ronguer	15 cm (6")	Straight	AISI 410	Mirror Polish	2
32	GBAI1025-32	Ruskin Ronguer	16 cm (6¼")	Straight	AISI 410	Mirror Polish	2
33	GBAI1025-33	Babcock Intestinal Forceps	20 cm (8")	Straight	AISI 410	Mirror Polish	2
34	GBAI1025-34	Babcock Intestinal Forceps	15 cm (6")	Straight	AISI 410	Mirror Polish	3
35	GBAI1025-35	Allis Tissue Forceps 4×5 Teeth	15 cm (6")	Straight	AISI 410	Mirror Polish	6
36	GBAI1025-36	Allis Tissue Forceps 4×5 Teeth	12 cm (4¾")	Straight	AISI 410	Mirror Polish	2
37	GBAI1025-37	Backhaus Towel Clamps	12 cm (4¾")	Straight	AISI 410	Mirror Polish	1
38	GBAI1025-38	Adson Forceps Serrated	13 cm (5¼")	Straight	AISI 410	Satin Finish	1
39	GBAI1025-39	Metzenbaum Scissors	21.5 cm (8½")	Straight	AISI 410	Mirror Polish	12
40	GBAI1025-40	U.S. Army Retractor (Set of 2)	-----	Straight	AISI 410	Mirror Polish	2
41	GBAI1025-41	Richardson Retractor w/ Sklar-Grip Handle (Medium)	-----	Double-Ended	AISI 410	Mirror Polish	1
42	GBAI1025-42	Richardson Retractor w/ Sklar-Grip Handle (Large)	-----	Curved	AISI 410	Mirror Polish	1
43	GBAI1025-43	Richardson Retractor w/ Sklar-Grip Handle	2.5 × 23 cm (1" × 9")	Straight	AISI 410	Mirror Polish	1
44	GBAI1025-44	Deaver Retractor #0	2.5 × 23 cm (1" × 13")	Straight	AISI 410	Mirror Polish	2
45	GBAI1025-45	Deaver Retractor #2	3.8 × 30 cm (1½" × 12")	-	AISI 410	Mirror Polish / Satin (Malleable)	2
46	GBAI1025-46	Deaver Retractor #3	5 × 30 cm (2" × 12")	Straight	AISI 420 / AISI 420 (Malleable)	Mirror Polish / Satin (Malleable)	2
47	GBAI1025-47	Deaver Retractor #4	2 × 18 cm (¾" × 7")	Double-Ended	AISI 420 / AISI 420 (Malleable)	Mirror Polish / Satin (Malleable)	1
48	GBAI1025-48	Zalkind Ribbon Retractor (Malleable)	2 × 18 cm (¾" × 7")	Curved	AISI 420 / AISI 420 (Malleable)	Mirror Polish / Satin (Malleable)	2
49	GBAI1025-49	Zalkind Ribbon Retractor (Malleable)	2.5 × 33 cm (1" × 13")	Malleable	AISI 410	Mirror Polish	2
50	GBAI1025-50	Zalkind Ribbon Retractor (Malleable)	3.8 × 33 cm (1½" × 13")	Malleable	AISI 410	Mirror Polish	2
51	GBAI1025-51	Senn Retractor Double Ended Sharp	16 cm (6¼")	Double-Ended	AISI 410	Mirror Polish	2
52	GBAI1025-52	Senn Retractor Double Ended Blunt	16 cm (6¼")	Double-Ended	AISI 410	Mirror Polish	2
53	GBAI1025-53	Schmidt Hemostat (Half Curved Jaws)	19 cm (7½")	Half Curved	AISI 410	Mirror Polish	2
54	GBAI1025-54	Balfour Abdominal Retractor	18 cm (7")	Self-Retaining	AISI 410	Mirror Polish	1
55	GBAI1025-55	Metzenbaum Scissors	18 cm (7")	Curved	AISI 410	Mirror Polish	2
56	GBAI1025-56	Foerster Sponge Forceps Serrated	24 cm (9½")	Straight	AISI 410	Mirror Polish	2
57	GBAI1025-57	Foerster Sponge Forceps Serrated	24 cm (9½")	Curved	AISI 410	Mirror Polish	2
TOTAL QUANTITY							158

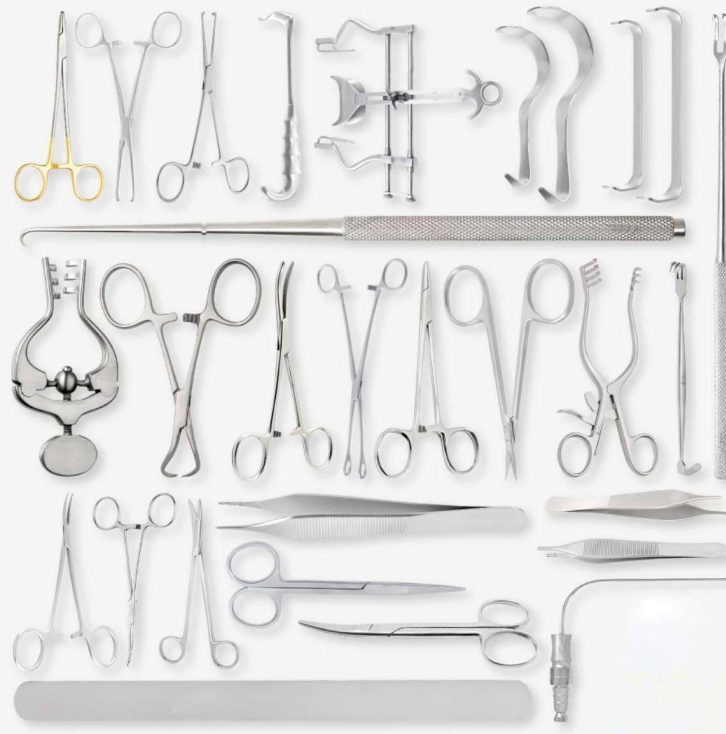

Laparotomy Pediatric Instruments Set-(GBAI-1031)

Sr. #	Code	Instrument Description	Specification	Type	Steel Type	Finish	QTY
01	GBAI1031-01	Baby Allis Tissue Forceps (Delicate)	14 cm (5½")	Straight	AISI 410	Satin	6
02	GBAI1031-02	Crile-Wood Needle Holder (TC Jaws, Smooth)	15 cm (6")	Straight	AISI 410	Satin	1
03	GBAI1031-03	Steel Ruler	15 cm	Straight	AISI 304	Mirror	1
04	GBAI1031-04	Allis Tissue Forceps 4x5 Teeth	24 cm (5½")	Straight	AISI 410	Satin	2
05	GBAI1031-05	Richardson Retractor Hollow Grip Handle	10 cm	Curved (1" x ¾" Blade)	AISI 410	Satin	2
06	GBAI1031-06	Balfour Abdominal Retractor Light Patter 4"	20 x 1.5 cm (8" x ¾")	Self-Retaining	AISI 410	Satin	1
07	GBAI1031-07	Ribbon Retractor (Malleable, Pediatric)	18 x 2 cm (7" x ¾")	Malleable	AISI 410	Satin	1
08	GBAI1031-08	Pediatric Deaver Retractor	12.5 cm (5")	Curved	AISI 410	Mirror	2
09	GBAI1031-09	Mixer Forceps Right Angle	9 cm (3½")	Double-Ended	AISI 410	Mirror	1
10	GBAI1031-10	Joseph Double Prong Skin Hook	9 cm (3½")	Straight (2 mm Wide)	AISI 410	Satin	2
11	GBAI1031-11	Joseph Double Prong Single Hook	16 cm (6¼")	Straight	AISI 410	Satin	3
12	GBAI1031-12	Ferguson Frazier Suction Tube	16 cm (6¼")	Curved	AISI 410	Satin	6
13	GBAI1031-13	Senn-Miller Retractor (3-Prong Sharp)	20 cm (8")	Double-Ended	AISI 410	Satin	3
14	GBAI1031-14	Weilbner Retractor (2x3 Teeth, Blunt)	20 cm (8")	Straight (2 mm Wide)	AISI 410	Satin	6
15	GBAI1031-15	Scissors (Straight, Sharp Tips)	16 cm (6¼")	Curved	AISI 410	Satin	2
16	GBAI1031-16	Jansen Mastoid Retractor 3x3 Teeth	16 cm (6¼")	Straight	AISI 410	Satin	1
17	GBAI1031-17	Rochester Ochsner Forceps	20 cm (8")	Curved	AISI 410	Satin	2
18	GBAI1031-18	Foerster Sponge Forceps (Serrated Jaws)	14 cm (5½")	Straight	AISI 410	Satin	1
19	GBAI1031-19	Gemini Mixer (Delicate, Full Curved Jaws)	20 cm (8")	Curved	AISI 410	Satin	1
20	GBAI1031-20	Crile Hemostatic Forceps	14 cm (5½")	Straight	AISI 410	Satin	8
21	GBAI1031-21	Crile-Rankin Hemostatic Forceps	16 cm (6¼")	Curved	AISI 410	Satin	1
22	GBAI1031-22	Halsted Mosquito Forceps	12 cm (4¾")	Curved	AISI 410	Satin	2
23	GBAI1031-23	Kelly Hemostatic Forceps	14 cm (5½")	Curved	AISI 410	Satin	1
24	GBAI1031-24	Halsted Mosquito Forceps	12 cm (4¾")	Straight	AISI 410 / Tungsten Carbide Inserts	Satin	2

Laparotomy Pediatric Instruments Set-(GBAI-1031)

Sr. #	Code	Instrument Description	Specification	Type	Steel Type	Finish	QTY
25	GBAI1031-25	Halsted Mosquito Forceps	12 cm (4¾")	Curved	AISI 410	Satin	2
26	GBAI1031-26	Adson Tissue Forceps (1×2 Teeth)	12 cm (4¾")	Straight	AISI 410	Satin	1
27	GBAI1031-27	Adson Brown Tissue Forceps (7×7 Teeth, Side Grasping)	12 cm (4¾")	Straight	AISI 410	Satin	1
28	GBAI1031-28	Adson Dressing Forceps (Serrated)	12 cm (4¾")	Straight	AISI 410	Satin	1
29	GBAI1031-29	Metzenbaum Dissecting Scissors	13 cm (5")	Curved	AISI 410	Satin	1
30	GBAI1031-30	Ragnell Dissecting Scissors	13 cm (5")	Straight	AISI 420	Mirror	1
31	GBAI1031-31	Iris Scissors (Curved, Sharp Tips)	11.5 cm (4½")	Curved	AISI 420	Mirror	1
						TOTAL QUANTITY	31



LAPROTOMY EMERGENCY SET-(GBAI-1057)

Sr. #	Code	Instrument Description	Specification	Type	Steel Type	Finish	QTY
01	1057-01	Scalpel Handle #3	14 cm	Straight	AISI 410	Satin	2
02	1057-02	Scalpel Handle #4	14 cm	Straight	AISI 410	Satin	1
03	1057-03	Mayo Scissors	17 cm	Straight	AISI 420	Satin	1
04	1057-04	Metzenbaum Scissors	18 cm	Curved	AISI 420	Satin	1
05	1057-05	Crile Hemostatic Forceps	14 cm	Curved	AISI 420	Satin	12
06	1057-06	Kelly Hemostatic Forceps	14 cm	Curved	AISI 420	Satin	12
07	1057-07	Rochester-Pean Hemostats	20 cm	Curved	AISI 420	Satin	6
08	1057-08	Foerster Sponge Forceps	24 cm	Straight	AISI 410	Satin	4
09	1057-09	Balfour Abdominal Retractor	7" spread	Self-Retaining	AISI 410	Satin	1
10	1057-10	Deaver Retractors (Set of 3)	#1, #3, #4	Curved	AISI 410	Satin	1
11	1057-11	Richardson Retractors (Set of 3)	Small/Med/Large	Curved	AISI 410	Satin	1
12	1057-12	Ribbon Retractor (Malleable)	2.5 cm x 33 cm	Bendable	AISI 410	Satin	1
13	1057-13	US Army Retractor (Set of 2)	21 cm	Double-Ended	AISI 410	Satin	1
14	1057-14	Backhaus Towel Clamp	13 cm	Curved	AISI 410	Satin	10
15	1057-15	Mayo-Hegar Needle Holder	20 cm	Straight	AISI 420	Satin	2
16	1057-16	Dressing Forceps Serrated	20 cm	Straight	AISI 420	Satin	2
TOTAL QUANTITY							58



Amputation Surgical Instrument Set(GBAI-1004)

Sr. #	Code	Instrument Description	Specification	Type	Steel Type	Finish	QTY
01	MA501R	Ferguson Frazier Suction Tube	9 Fr	-	AISI 304 / 316L	Mirror Polish	1
02	MB681R	Hibbs Osteotomes	240mm x 2.5 mm	-	AISI 420 / 420A	Mirror Polish	1
03	MA039R	Lempert Curette Teardrop Cup Size	20 cm	-	AISI 420 / 440A	Mirror Polish	1
04	MG058R	Ruskin Rongeur Straight Double Action	150mm x 3mm	-	AISI 410 / 420	Satin Finish	1
05	OL620R	Joseph Hook Sharp Single Prong	16.5 cm	-	AISI 410 / 420	Mirror Polish	2
06	MA185R	Joseph Double Prong Skin Hook	150mm x 2mm	-	AISI 410 / 420	Mirror Polish	2
07	FK410R	Key Elevator Squared 0.25"	19 cm	-	AISI 410 / 420	Satin Finish	1
08	FK412R	Key Elevator Squared 0.5"	19 cm	-	AISI 410 / 420	Satin Finish	1
09	FO518R	Ruskin Rongeur Straight Double Action	190 mm x 5mm	-	AISI 410 / 420	Mirror Polish	1
10	MB675R	Hibbs Osteotome	19.5cm x 17mm	Straight	AISI 420 / 440A	Mirror Polish	1
11	MB677R	Hibbs Osteotome	240 mm x 6mm	Straight	AISI 420 / 440A	Mirror Polish	1
12	MB679R	Hibbs Osteotome	240 mm x 13mm	Straight	AISI 420 / 440A	Mirror Polish	4
13	FO462R	Luer Rongeur Single Action	240 mm x 19mm	Straight	AISI 410 / 420	Mirror Polish	1
14	MB683R	Hibbs Osteotomes	180mm x 9.5mm x 33 mm	Straight	AISI 420 / 420J2	Satin Finish	1
15	OL165R	Freer Elevator Double Ended With Blunt Sharp Blades	240mm x 32mm	-	AISI 410 / 420	Satin Finish	1
16	FK505R	Putti Bone Rasp Double-Ended Flat	180mm x 5mm	-	AISI 420 / 440A	Mirror Polish	1
17	FO634R	Liston Bone Cutting Forcep Straight	260mm	-	AISI 420 / 440A	Mirror Polish	1
18	FH325R	Satterlee Bone Saw Light Metal Handle	185mm	-	AISI 420 / 440A	Mirror Polish	1
19	FH102R	Liston Amputation Knife Blade	30cm	-	AISI 420 / 440A	Mirror Polish	1
20	BB074R	Knife Handle	20cm	-	AISI 420A	Satin Finish	1
21	BB084R	Knife Handle	#3	-	AISI 316L	Satin Finish	1
22	MG235R	Allis Tissue 4 x 5 Teeth	#4	-	AISI 410 / 420	Satin Finish	4
23	Fh414	Modified Gigli Bone Saw Wire – Turnable	15 cm	-	AISI 410 / 420	Satin Finish	2
24	MB279R	Langenbeck Elevator Sharp	12 cm	-	AISI 410 / 420	Satin Finish	1

Amputation Surgical Instrument Set (GBAI-1004)

Sr. #	Code	Instrument Description	Specification	Type	Steel Type	Finish	QTY
25	ACLPLCL-1045	Bailey Saw Guide	30cm	-	AISI 410 / 420	Satin Finish	1
26	BM029R	Tungsten Carbide Inserted Crilewood	14 cm	-	AISI 410 + Tungsten Carbide	Satin Finish	1
27	BC250R	Mayo Scissors with Tungsten Carbide	15 cm	-	AISI 410 + (TC) Jaws	Mirror Polish	1
28	BC263W	Metzenbaum Scissors with Tungsten Carbide	14 cm	Curved	AISI 410 + Carbide Inserts	Satin Finish	1
29	BC861R	Lister Bandage Scissors	18 cm	-	AISI 420 / 420J2	Mirror Polish	2
30	BD511R	Thumb Tissue Forcep 1 x 2 Teeth	14 cm	-	AISI 410 / 420	Mirror Polish	2
31	MG235R	Tissue Forcep 4 x 5 Teeth	15 cm	-	AISI 410 / 420	Satin Finish	1
32	BD222R	Adson Dressing Forceps Serrated	15 cm	Straight	AISI 420 / 420J2	Satin Finish	1
33	PH.18.12	Halstead Mosquito Forceps	12-cm	Curved	AISI 410 / 420	Satin Finish	4
34	PH.19.12	Halstead Mosquito Forceps	12 cm	Curved	AISI 410 / 420	Mirror Polish	4
35	BH614R	Kocher Forceps	12 cm	Straight	AISI 410 / 420	Mirror Polish	4
36	BH135R	Kelly Hemostatic Forceps	14 cm	Curved	AISI 410 / 420	Mirror Polish	4
37	BF433R	Backhaus Towel Clamps	14 cm	-	AISI 420A	Mirror Polish	6
38	BM014R	Webster Needle Holder Smooth Jaws	13 cm	-	AISI 410 + Tungsten	Satin Finish	6
39	OL165R	Mayo Scissors Tungsten Carbide	14 cm	Curved	AISI 410 + (TC) Inserts	Satin Finish	6
40	BT008R	Senn Miller Retractor 3 Prongs Sharp	16 cm	-	AISI 410 / 440A	Mirror Polish	1
41	BT007R	Senn Miller Retractor 3 Prongs Blunt	16 cm	-	AISI 410 / 440A	Mirror Polish	1
42	BT315R	Langenbeck Retractor	20cm x 38mm	-	AISI 410 / 440A	Mirror Polish	1
43	BT311R	Langenbeck Retractor	22 cm x 38mm	-	AISI 410 / 440A	Mirror Polish	1
44	MG260R	Volkman Retractor 2 Prongs Sharp	22 cm	-	AISI 410 / 420	Satin Finish	1
45	MG261R	Volkman Retractor 3 Prongs Sharp	22 cm	-	AISI 410 / 420	Satin Finish	1
46	BT505R	Hibbs Retractor	23 cm x 7.5 mm	-	AISI 410 / 420	Satin Finish	1
47	BV071R	Weitlaner Retractor 3x4 Teeth Sharp	14 cm	-	AISI 410 / 420	Satin Finish	1
48	BV074R	Weitlaner Retractor 3x4 Teeth Blunt	14 cm	-	AISI 410 / 420	Mirror Polish	1
49	AA805R	Steel Ruler	-----	-	AISI 304	Matte Finish	1
TOTAL QUANTITY							79



Dressing Set Instruments(GBAI-1020)

Sr. #	Code	Instrument Description	Specification	Type	Steel Type	Finish	QTY
01	GBAI1020-01	Mayo Scissors TC	14 cm	Straight	AISI 420 / 440A	Mirror Polish	1
02	GBAI1020-02	Lister Bandage Scissors	15 cm	Straight	AISI 420 / 420J2	Mirror Polish	1
03	GBAI1020-03	Dissecting Scissors Sharp/Blunt	14 cm	Straight	AISI 420 / 420J2	Mirror Polish	1
04	GBAI1020-04	Spencer Stitch Scissors	11 cm	Straight	AISI 420 / 420J2	Mirror Polish	1
05	GBAI1020-05	Dressing Forceps	16 cm	Straight	AISI 410 / 420	Mirror Polish	2
06	GBAI1020-06	Foerster Sponge Forceps	25 cm	Straight	AISI 410 / 420	Mirror Polish	1
07	GBAI1020-07	Dressing Forceps 1:2 Teeth	16 cm	Straight	AISI 410 / 420	Mirror Polish	2
08	GBAI1020-08	Kelly Forceps	14 cm	Straight	AISI 410 / 420	Mirror Polish	1
09	GBAI1020-09	Lotion Bowl	4 oz capacity	Straight	AISI 304 / 316L	Mirror Polish	1
10	GBAI1020-10	Adson Forceps	12 cm	Straight	AISI 410 / 420	Mirror Polish	1
11	GBAI1020-11	Kidney Dish	20 cm (8")	Straight	AISI 304 / 316L	Mirror Polish	2
						TOTAL QUANTITY	14



Minor Basic Instrument Set(GBAI=1037)

Sr. #	Code	Instrument Description	Specification	Type	Steel Type	Finish	QTY
01	GBAI1037-01	Knife Handle No. 3	13 cm	Straight	AISI 410	Mirror	1
02	GBAI1037-02	Probe with Eye	15 cm	Straight	AISI 410	Satin	1
03	GBAI1037-03	Backhaus Towel Clamp	13 cm (5¼")	Straight	AISI 410	Mirror	2
04	GBAI1037-04	Etraction Dressing Forceps (Serrated)	14 cm (5½")	Straight	AISI 420	Mirror	1
05	GBAI1037-05	Allis Tissue Forceps (4x5 Teeth)	15 cm (6")	Straight	AISI 420	Mirror	1
06	GBAI1037-06	Allis Tissue Forceps (1x2 Teeth)	12 cm (4¾")	Straight	AISI 420	Mirror	1
07	GBAI1037-07	Rochester Pean Forceps	20 cm (8")	Curved	AISI 420	Satin	1
08	GBAI1037-08	Mayo Dissecting Scissors	17 cm (6¾")	Straight	AISI 410	Mirror	1
09	GBAI1037-09	Thumb Tissue Forceps (Plain)	14 cm(5½")	Straight	AISI 410	Mirror	1
10	GBAI1037-10	Halsted Mosquito Forceps	12.5 cm (5")	Curved	AISI 420	Satin	2
11	GBAI1037-11	Rochester Ochsner Forceps	20 cm (8")	Straight	AISI 420	Satin	1
12	GBAI1037-12	Foerster Sponge Forceps (Serrated Jaws)	24 cm (9½")	Straight	AISI 420	Satin	1
13	GBAI1037-13	Senn-Miller Retractor (Double Ended, Sharp)	16 cm (6¼")	Double-Ended	AISI 420	Mirror	1
14	GBAI1037-14	Richardson Retractor (Hollow Grip Handle)	24 cm (9½")	Curved	AISI 420	Mirror	1
15	GBAI1037-15	Weitlaner Retractor (2x3 Teeth, Blunt)	10 cm (4")	Self-Retaining	AISI 420	Mirror	1
16	GBAI1037-16	Metzenbaum Scissors (Fine, Curved)	18 cm (7")	Curved	AISI 420	Mirror	1
17	GBAI1037-17	Richardson Retractor (Large Blade)	5 cm (10")	Curved	AISI 420	Mirror	1
						TOTAL QUANTITY	19



Gynecology Instruments Set(GBAI-1026)

Sr. #	Code	Instrument Description	Specification	Type	Steel Type	Finish	QTY
01	GBAI1026-01	Sponge Holding Forceps	18 cm	Straight	AISI 420	Satin	2
02	GBAI1026-02	Auvarud Vaginal Speculum	70 x 38 mm	Curved (Bivalve Type)	AISI 304	Mirror	2
03	GBAI1026-03	Episiotomy Scissors	14 cm	Curved (Oblique Blades)	AISI 420	Satin	2
04	GBAI1026-04	Mayo Hegar Needle Holder	18 cm	Straight	AISI 410	Satin	4
05	GBAI1026-05	Umbilical Cord Scissors (USA Model)	-----	Curved	AISI 410	Mirror	2
06	GBAI1026-06	Sims Vaginal Spatula (Set of 3)	-----	Double-Ended / Flat	AISI 304	Polished	1
07	GBAI1026-07	Kidney Tray	-----	-	AISI 304	Mirror	2
08	GBAI1026-08	Iodine Cup	-----	-	AISI 304	Mirror	1
09	GBAI1026-09	Spencer-Wells Artery Forceps	14 cm	-	AISI 410	Satin	2
10	GBAI1026-10	Kocher Ochsner Forceps	18 cm	Straight	AISI 410	Satin	2
11	GBAI1026-11	BP Handle No. 4	-----	Straight	AISI 410	Satin	2
12	GBAI1026-12	Instrument Tray	-----	Straight	AISI 304	Mirror	2
				-		TOTAL QUANTITY	24



C-SECTION SET - (GBAI-1059)

Sr. #	Code	Instrument Description	Specification	Type	Steel Type	Finish	QTY
01	1059-01	Scalpel Handle #3	14 cm	Straight	AISI 410	Satin	2
02	1059-02	Scalpel Handle #4	14 cm	Straight	AISI 410	Satin	1
03	1059-03	Mayo Scissors	17 cm	Straight	AISI 420	Satin	1
04	1059-04	Metzenbaum Scissors	18 cm	Curved	AISI 420	Satin	1
05	1059-05	Lister Bandage Scissors	14 cm	Curved	AISI 420	Satin	1
06	1059-06	Allis Tissue Forceps 5x6	15 cm	Curved	AISI 420	Satin	6
07	1059-07	Babcock Forceps	16 cm	Curved	AISI 420	Satin	6
08	1059-08	Crile Hemostats	14 cm	Straight	AISI 410	Satin	12
09	1059-09	Kelly Hemostats	14 cm	Curved	AISI 410	Satin	12
10	1059-10	Foerster Sponge Forceps	24 cm	Curved	AISI 410	Satin	4
11	1059-11	Deaver Retractor #4	2" x 12"	Straight	AISI 410	Satin	2
12	1059-12	Richardson Retractors (Pair)	Small & Medium	Bendable	AISI 410	Satin	2
13	1059-13	US Army Retractor (Set of 2)	21 cm	Double-Ended	AISI 410	Satin	1
14	1059-14	Backhaus Towel Clamp	13 cm	Curved	AISI 410	Satin	10
15	1059-15	Mayo-Hegar Needle Holder	20 cm	Straight	AISI 420	Satin	2
16	1059-16	Dressing Forceps Serrated	20 cm	Straight	AISI 420	Satin	2
17	1059-17	Uterine Sound	32 cm	Straight	AISI 410	Satin	1
TOTAL QUANTITY							66



IUD INSERTION SET - (GBAI-1061)

Sr. #	Code	Instrument Description	Specification	Type	Steel Type	Finish	QTY
01	1061-01	Cusco Vaginal Speculum (M)	-----	Bivalve	AISI 410	Satin	1
02	1061-02	Cusco Vaginal Speculum (L)	-----	Bivalve	AISI 410	Satin	1
03	1061-03	Uterine Sound (Malecot)	32 cm	Straight	AISI 410	Satin	1
04	1061-04	Uterine Dressing Forceps	10" (25 cm)	Straight	AISI 420	Satin	1
05	1061-05	Ayre's Spatula (Wood)	-----	Disposable	Wood	Natural	10
06	1061-06	Pozzi Tenaculum Forceps	9" (23 cm)	Single Tooth	AISI 420	Satin	1
07	1061-07	Kelly Forceps	5½" (14 cm)	Curved	AISI 420	Satin	2
08	1061-08	Sims Uterine Curette	M (8-10 mm)	Curved	AISI 420	Satin	1
09	1061-09	Graves Speculum (S)	-----	Bivalve	AISI 410	Satin	1
10	1061-10	Ring Forceps	9½" (24 cm)	Straight	AISI 420	Satin	1
11	1061-11	Long Spencer Stitch Scissors	7" (18 cm)	Straight	AISI 420	Satin	1
12	1061-12	Uterine Dilators Set (Hegar)	Sizes 3-10	Straight	AISI 420	Satin	1
13	1061-13	Sponge Holding Forceps	9½" (24 cm)	Curved	AISI 410	Satin	1
14	1061-14	IUD Inserter (TCu380A type)	-----	Disposable	AISI 410	Satin	5
TOTAL QUANTITY							28



D & C Set (Dilation and Curettage Instrument Set) (GBAI-1079)

Sr. #	Code	Instrument Description	Specification	Type	Steel Type	Finish	QTY
01	GBAI-2003-01	Sponge Holding Forceps	25 cm	Straight	AISI 410	Satin	1
02	GBAI-2003-02	Uterine Sound (Graduated)	25 cm	Curved	AISI 420A	Satin	1
03	GBAI-2003-03	Cervical Tenaculum Forceps (Single Tooth)	25 cm	Curved	AISI 410	Satin	1
04	GBAI-2003-04	Sims Uterine Sound	25 cm	Slightly Curved	AISI 420A	Satin	1
05	GBAI-2003-05	Hegar Uterine Dilators (Set of 10)	Sizes 1–10, Double Ended	Straight	AISI 420A	Mirror	1 set
06	GBAI-2003-06	Sharp Curette Set	Sizes 1–5	Curved	AISI 420A	Satin	1 set
07	GBAI-2003-07	Blunt Curette Set	Sizes 1–5	Curved	AISI 420A	Satin	1 set
08	GBAI-2003-08	Sims Vaginal Speculum (Medium)	75×25 mm	Right & Left Blades	AISI 410	Satin	1
09	GBAI-2003-09	Sims Vaginal Speculum (Large)	100×30 mm	Right & Left Blades	AISI 410	Satin	1
10	GBAI-2003-10	Cusco's Bivalve Speculum (Medium)	Adjustable	Self-Retaining	AISI 410	Satin	1
11	GBAI-2003-11	-----	-----	-----	-----	-----	—
12	GBAI-2003-12	Metzenbaum Scissors	18 cm	Scissors	AISI 420	Mirror	1
13	GBAI-2003-13	Kocher Artery Forceps	16 cm	Forceps	AISI 410	Satin	2
14	GBAI-2003-14	Stainless Steel Bowl	6"	Bowl	SS 304	Mirror	2
15	GBAI-2003-15	Kidney Tray	8"	Tray	SS 304	Mirror	1
TOTAL QUANTITY							16

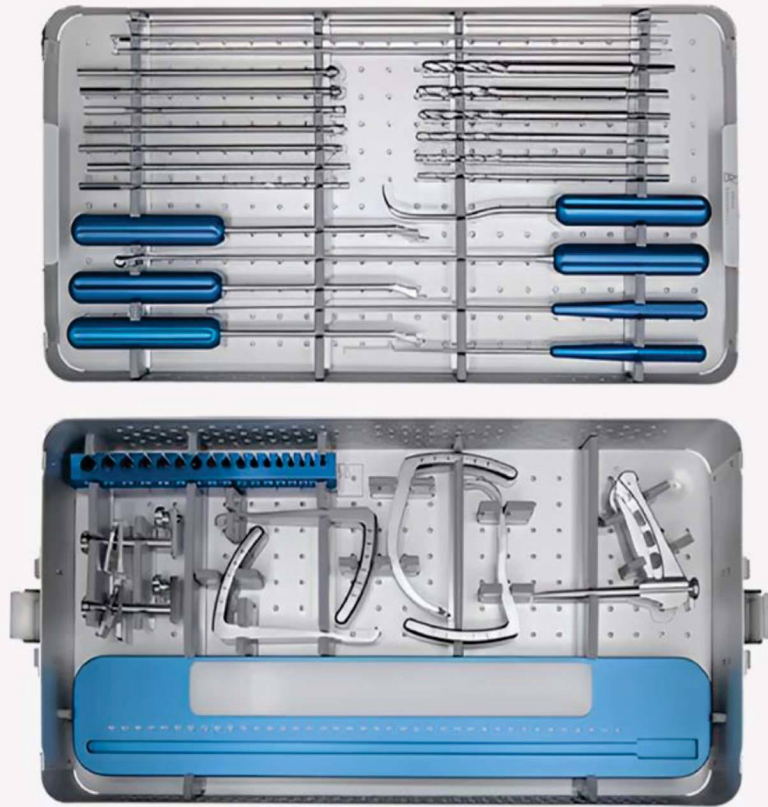

ACL PCL INSTRUMENT SET (GBAI-1003)

Sr. #	Code	Instrument Description	Specification	Type	Steel Type	Finish	QTY
01	ACL PCL-1001	Elbow Aimer	-	-	AISI 410 / 420	Satin / Mirror Polish	1
02	ACL PCL-1002	Main Zig	-	-	AISI 410 / 420	Satin / Mirror Polish	1
03	ACL PCL-1003	PCL Tibial	-	-	AISI 410 / 420	Satin / Mirror Polish	1
04	ACL PCL-1004	Angle Bullate	-	-	AISI 420 / 440A	Mirror Polish	1
05	ACL PCL-1005	Cannulated Tibial Reamer	Dia 6mm	-	AISI 420 / 440A	Mirror Polish	1
06	ACL PCL-1006	Cannulated Tibial Reamer	Dia 7mm	-	AISI 420 / 440A	Mirror Polish	1
07	ACL PCL-1007	Cannulated Tibial Reamer	Dia 8mm	-	AISI 420 / 440A	Mirror Polish	1
08	ACL PCL-1008	Cannulated Tibial Reamer	Dia 9mm	-	AISI 420 / 440A	Mirror Polish	1
09	ACL PCL-1009	Cannulated Tibial Reamer	Dia 10mm	-	AISI 420 / 440A	Mirror Polish	1
10	ACL PCL-1010	Cannulated Tibial Reamer	Dia 11mm	-	AISI 420 / 440A	Mirror Polish	1
11	ACL PCL-1011	Cannulated Tibial Reamer	Dia 12mm	-	AISI 420 / 440A	Mirror Polish	1
12	ACL PCL-1012	Graft Passing Drill Bit	2.4mm	-	AISI 420 / 440A	Mirror Polish	4
13	ACL PCL-1013	Graft Passing Bin (Beath Pin)	Dia 2.4mm	-	AISI 420 / 440A	Mirror Polish	1
14	ACL PCL-1014	Cannulated Femoral Flowertip Reamer	Dia 6mm	-	AISI 420 / 440A	Mirror Polish	1
15	ACL PCL-1015	Cannulated Femoral Flowertip Reamer	Dia 7mm	-	AISI 420 / 440A	Mirror Polish	1
16	ACL PCL-1016	Cannulated Femoral Flowertip Reamer	Dia 8mm	-	AISI 420 / 440A	Mirror Polish	1
17	ACL PCL-1017	Cannulated Femoral Flowertip Reamer	Dia 9mm	-	AISI 420 / 440A	Mirror Polish	1
18	ACL PCL-1018	Cannulated Femoral Flowertip Reamer	Dia 10mm	-	AISI 420 / 440A	Mirror Polish	1
19	ACL PCL-1019	Cannulated Femoral Flowertip Reamer	Dia 11mm	-	AISI 420 / 440A	Mirror Polish	1

ACL PCL INSTRUMENT SET (GBAI-1003)

Sr. #	Code	Instrument Description	Specification	Type	Steel Type	Finish	QTY
20	ACLPCL-1020	Cannulated Endoscopic Reamer	Dia 4.5mm	-	AISI 410 / 420	Mirror Polish	1
21	ACLPCL-1021	Tunnel Plug	7-8 mm	-	AISI 420 / 420J2	Satin Finish	1
22	ACLPCL-1022	Tunnel Plug	8-9 mm	-	AISI 420 / 420J2	Satin Finish	1
23	ACLPCL-1023	Tunnel Plug	9-10 mm	-	AISI 420 / 420J2	Satin Finish	1
24	ACLPCL-1024	Tunnel Dilator	7 mm	-	AISI 410 / 420	Satin Finish	1
25	ACLPCL-1025	Tunnel Dilator	8 mm	-	AISI 410 / 420	Satin Finish	1
26	ACLPCL-1026	Tunnel Dilator	9 mm	-	AISI 410 / 420	Satin Finish	1
27	ACLPCL-1027	Depth Gauge for ACL/PCL reconstruction	-	-	AISI 420 / 440A	Satin Finish	1
28	ACLPCL-1028	Femoral Aimer	5 mm	-	AISI 420A	Satin Finish	1
29	ACLPCL-1029	Femoral Aimer	7 mm	-	AISI 420 / 420J2	Satin Finish	1
30	ACLPCL-1030	T- Handle for Tunnel Dilators	-	-	AISI 420 / 440A	Satin Finish	1
31	ACLPCL-1031	Impactor for Spiked Ligament Staple	-	-	AISI 420A	Mirror Polish	1
32	ACLPCL-1032	Graft Prep Station	-	-	AISI 420 / 420J2	Mirror Polish	1
33	ACLPCL-1033	Graft Prep Probe	-	-	AISI 420 / 420J2	Satin Finish	1
34	ACLPCL-1034	Arthroscopic Probe	-	-	AISI 420 / 420J2	Mirror Polish	1
35	ACLPCL-1035	Microfracture Awl	30°	-	AISI 420 / 420J2	Mirror Polish	1
36	ACLPCL-1036	Microfracture Awl	60°	-	AISI 410 / 420	Mirror Polish	1
37	ACLPCL-1037	Microfracture Awl	90°	-	AISI 410 / 420	Mirror Polish	1
38	ACLPCL-1038	Tendon Stripper, Closed end	6 mm	-	AISI 410 / 420	Satin Finish	1
39	ACLPCL-1039	Tendon Stripper, Open end	7 mm	-	AISI 420 / 420J2	Mirror Polish	1
40	ACLPCL-1040	Femoral PCL Elevator	-----	-	AISI 420 / 420J2	Mirror Polish	1
41	ACLPCL-1041	Straight Rasp	-----	-	AISI 420 / 420J2	Mirror Polish	1
42	ACLPCL-1042	Convex Rasp	-----	-	AISI 410 / 420	Mirror Polish	1
43	ACLPCL-1043	Trocar Pin	-----	-	AISI 410 / 420	Mirror Polish	1
44	ACLPCL-1044	Empty Container for Knee Arthroscopy Instruments	-----	-	AISI 304 (for Container)	Mirror Polish	1
						TOTAL QUANTITY	44



Basic Orthopedic Instrument Set-(GBAI-1010)

Sr. #	Code	Instrument Description	Specification	Type	Steel Type	Finish	QTY
01	GBAI1010-01	Scalpel Handle	4	-	AISI 410 / 420	Mirror Polish	1
02	GBAI1010-02	Lister Bandage Scissors	20 CM	-	AISI 420 / 420J2	Mirror Polish	1
03	GBAI1010-03	Operating Scissors S/S	14 CM	STRAIGHT	AISI 420 / 420J2	Mirror Polish	1
04	GBAI1010-04	Operating Scissors S/B	14 CM	STRAIGHT	AISI 420 / 420J2	Mirror Polish	2
05	GBAI1010-05	Operating Scissors S/B	14 CM	CURVED	AISI 420 / 420J2	Mirror Polish	1
06	GBAI1010-06	Stitch Scissors Standard	14 CM	STRAIGHT	AISI 420 / 420J2	Mirror Polish	1
07	GBAI1010-07	Mayo Dissecting Scissors	17 CM	ANGLED	AISI 420 / 420J2	Mirror Polish	2
08	GBAI1010-08	TC Wire Cutting Scissors Angled	17 CM	CURVED	AISI 410 + Tungsten Carbide (TC) Blades	Satin Finish (TC Edges)	1
09	GBAI1010-09	Mixter Forceps Right Angle	12 CM	ANGLED	AISI 420 / 440	Satin Finish	4
10	GBAI1010-10	Kelly Forceps	18 Cm	STRAIGHT	AISI 420 / 440	Satin Finish	12
11	GBAI1010-11	Kelly Forceps	14 CM	CURVED	AISI 420 / 440	Satin Finish	12
12	GBAI1010-12	Rochester-Pean Forceps	14 CM	CURVED	AISI 420 / 440	Satin Finish	3
13	GBAI1010-13	Rochester-Pean Forceps	18 CM	CURVED	AISI 410 / 420	Mirror Polish	3
14	GBAI1010-14	Dressing Forceps	18 CM	-	AISI 410 / 420	Mirror Polish	2
15	GBAI1010-15	Dressing Forceps	14 CM	-	AISI 410 / 420	Mirror Polish	2
16	GBAI1010-16	Tissue Forceps 1x2 Teeth	14 CM	-	AISI 410 / 420	Mirror Polish	1
17	GBAI1010-17	Tissue Forceps 1x2 Teeth	20 CM	-	AISI 420 / 420J2	Mirror Polish	1
18	GBAI1010-18	TC Mayo-Hegar Serr	18 CM	-	AISI 410 + Tungsten Carbide	Satin Finish (TC Jaws)	1
19	GBAI1010-19	TC Mayo-Hegar Serr	15 CM	-	AISI 410 + Tungsten Carbide	Satin Finish (TC Jaws)	1
20	GBAI1010-20	Allis Tissue Forceps 4x5 Teeth	15 CM	-	AISI 410 + Tungsten Carbide	Satin Finish (TC Jaws)	1
21	GBAI1010-21	Allis Tissue Forceps 4x4 Teeth	19 CM	-	AISI 420 / 440A	Mirror Polish	2
22	GBAI1010-22	Needle Nose Pliers	14 CM	-	AISI 420 / 440B	Mirror Polish	2
23	GBAI1010-23	Bone/Cartilage Clamp	20 CM	-	AISI 420 / 440B	Mirror Polish	2
24	GBAI1010-24	Kern Bone Forceps w/0 Ratchet Extra	13 CM	-	AISI 420 / 440A	Mirror Polish	1

Basic Orthopedic Instrument Set-(GBAI-1010)

Sr. #	Code	Instrument Description	Specification	Type	Steel Type	Finish	QTY
25	GBAI1010-25	Kern Forceps	22 CM	-	AISI 410 / 420	Satin Finish	1
26	GBAI1010-26	Lewin Bone Forceps Serr	18 CM	-	AISI 410 / 420	Satin Finish	1
27	GBAI1010-27	Lowman Clamp Small	SMALL	-	AISI 410 / 420	Mirror Polish	1
28	GBAI1010-28	Lowman Clamp 1"x 1 ½	12 CM	-	AISI 410 / 420	Satin Finish	1
29	GBAI1010-29	Lister Bandage Scissors	19.5 CM	-	AISI 410 / 420	Mirror Polish	1
30	GBAI1010-30	Liston Bone Forceps Angled	26 CM	-	AISI 420 / 440A	Mirror Polish	1
31	GBAI1010-31	Beyer Ronguer	18 CM	-	AISI 420 / 440A	Satin Finish	1
32	GBAI1010-32	Ruskin Ronguer	18 CM	-	AISI 420 / 440A	Satin Finish	1
33	GBAI1010-33	Hajek Bone Mallet	20-CM	-	AISI 420 / 440A	Satin Finish	1
34	GBAI1010-34	Halstead Mosquito Forceps	24 CM X 10MM	-	AISI 420 / 440A	Mirror Polish	1
35	GBAI1010-35	Hibbs Osteotome	24 CM X 13MM	-	AISI 420 / 440A	Mirror Polish	1
36	GBAI1010-36	Hibbs Osteotome	24 CM X 10MM	-	AISI 420 / 440A	Mirror Polish	1
37	GBAI1010-37	Backhaus Towel Clamps	24 CM X 13MM	-	AISI 420 / 440A	Mirror Polish	1
38	GBAI1010-38	KEY ELEVATOR	19 CM	-	AISI 420 / 440A	Satin Finish	1
39	GBAI1010-39	KEY ELEVATOR	19 CM	-	AISI 420 / 440A	Satin Finish	1
40	GBAI1010-40	Senn Miller Retractor 3 Prongs Sharp	18 CM	-	AISI 420 / 440A	Mirror Polish	1
41	GBAI1010-41	Senn Miller Retractor 3 Prongs Blunt	18 CM	-	AISI 420 / 440A	Mirror Polish	1
42	GBAI1010-42	Langenbeck Retractor	17 CM	-	AISI 420 / 440A	Mirror Polish	1
43	GBAI1010-43	Backhaus Towel Clamp	15 CM	-	AISI 420 / 440A	Mirror Polish	4
44	GBAI1010-44	Backhaus Towel Clamp	16.5 CM	-	AISI 420 / 440A	Satin Finish	12
45	GBAI1010-45	Volkman Retractor 3 Prongs Sharp	9 CM	-	AISI 420 / 440A	Mirror Polish	1
46	GBAI1010-46	Frazier Suction Tube	19CM	-	AISI 420 / 420J2	Satin Finish	2
47	GBAI1010-47	Frazier Suction Tube	12 FR	-	AISI 420 / 420J2	Satin Finish	2
48	GBAI1010-48	Frazier Suction Tube	19 CM	-	AISI 410 / 420	Mirror Polish	2
						TOTAL QUANTITY	106



Broken Screw Removal Set-(GBAI-1014)

Sr. #	Code	Instrument Description	Specification	Type	Steel Type	Finish	QTY
01	GBAI1014-01	Forceps for screw removal	14 cm	Straight	AISI 410 / 420	Mirror Polish	1
02	GBAI1014-02	Quick change handle (straight)	13 cm	Straight	AISI 410 / 420	Mirror Polish	1
03	GBAI1014-03	Quick change handle (T type)	13 cm	T-Type	AISI 410 / 440	Mirror Polish	1
04	GBAI1014-04	Extraction bolt(φ3.5/φ4.5)	φ3.5 / φ4.5	Straight	AISI 410 / 420 (Handle: Silicone Grip)	Satin Finish (Silicone Handle)	2
05	GBAI1014-05	Bone chisel (silicone handle)	18 mm (width)	Straight	AISI 410 / 420	Mirror Polish	1
06	GBAI1014-06	Cross screwdriver	150 mm	Straight	AISI 410 / 420	Mirror Polish	1
07	GBAI1014-07	A.O Hex head screwdrive	SW1.5/2.0/2.5/3.0/3.5/4.0/4.5/5.0/5.5	Straight	AISI 410 / 420	Mirror Polish	9
08	GBAI1014-08	Square screwdriver (1.1mm/1.2mm/1.5mm)	1.1 mm / 1.2 mm / 1.5 mm	Straight	AISI 410 / 420	Satin Finish	3
09	GBAI1014-09	Star screwdriver(T2.3/T2.7/3)	T2.3 / T2.7 / T3.2 / T3.4 / T3.8 / T4.3 / T5.3	Straight	AISI 410 / 420	Mirror Polish	7
10	GBAI1014-10	Sonical extraction screw	150 mm	Straight	AISI 420A	Mirror Polish	4
11	GBAI1014-11	A screwdriver	150 mm	Straight	AISI 410 / 420	Mirror Polish	1
12	GBAI1014-12	Halsted Curved Mosquito	12.5 cm	Straight	AISI 410 / 420	Mirror Polish	1
13	GBAI1014-13	Bishop Harmon Straight	8.5 cm	Straight	AISI 410 / 420	Mirror Polish	4
14	GBAI1014-14	HSS Drill Bit	2.0 mm / 2.5 mm / 3.0 mm / 3.5 mm / 4.0 mm / 4.5 mm	Straight	HSS (High Speed Steel)	Bright Finish	3
15	GBAI1014-15	Sharp screwdriver	150 mm	Straight	AISI 410 + TC Jaws	Mirror Polish	1
16	GBAI1014-16	Broken screw extractor	9.5 cm	Straight	AISI 410 / 420	Mirror Polish	7
17	GBAI1014-17	Sharp hook	M2-M5	Straight	AISI 410 / 420	Mirror Polish	1
18	GBAI1014-18	Instrument box	20 × 10 × 5 cm	Straight	AISI 304 / 316L	Matte Finish (Instrument Box Interior)	1
TOTAL QUANTITIES							49

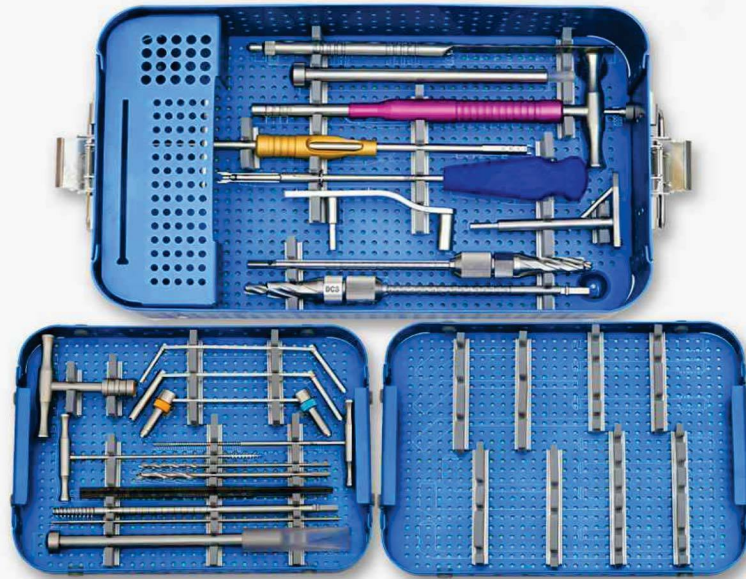

DHS DCS Instrument Set(GBAI-1018)

Sr. #	Code	Instrument Description	Specification	Type	Steel Type	Finish	QTY
01	GBAI1018-01	DHS/DCS Direct Measuring Device	40–150 mm	Straight	AISI 420 / 420J2	Mirror Polish	1
02	GBAI1018-02	DHS/DCS One-Step Insertion Wrench	----	Straight	AISI 420 / 420J2	Mirror Polish	1
03	GBAI1018-03	DHS/DCS Impactor	9 mm	Straight	AISI 420 / 420J2	Mirror Polish	1
04	GBAI1018-04	DHS/DCS Wrench for DHS Screw	7 mm	Straight	AISI 420 / 420J2	Mirror Polish	1
05	GBAI1018-05	DHS/DCS Impactor	20 mm	Straight	AISI 420 / 420J2	Mirror Polish	1
06	GBAI1018-06	90° DCS Drill Guide	90°	Angular (90°)	AISI 410 / 420	Mirror Polish	1
07	GBAI1018-07	DHS Angle Guide	135°	Angular (135°)	AISI 410 / 420	Mirror Polish	1
08	GBAI1018-08	DHS/DCS Centering Sleeve for One	-----	Straight	AISI 420 / 440A	Mirror Polish	1
09	GBAI1018-09	DHS Reaming Head	-----	Straight	AISI 420 / 440A	Mirror Polish	1
10	GBAI1018-10	DHS Reaming Head	-----	Straight	AISI 410 / 420	Mirror Polish	1
11	GBAI1018-11	T-Handle with Quick Coupling	-----	T-Type Handle	AISI 410 / 420	Mirror Polish	1
12	GBAI1018-12	DHS/DCS Centering Sleeve Long	-----	Straight	AISI 410 / 420	Mirror Polish	1
13	GBAI1018-13	Screw Tap	-----	Straight	AISI 410 / 420	Mirror Polish	1
14	GBAI1018-14	Threaded Guide Wire, Trocar Point	4.5 mm	Straight	AISI 410 / 420	Mirror Polish	1
15	GBAI1018-15	T-Handle with Quick Coupling	2.5 mm × 230 mm	T-Type Handle	AISI 410 / 420	Mirror Polish	1
16	GBAI1018-16	Iodine / Solution Cup	-----	Straight	AISI 304 / 316L	Mirror Polish	1
17	GBAI1018-17	Alm Retractor 4x4 Teeth, Blunt	20–90 mm	Straight	AISI 304 / 316L	Mirror Polish	1
18	GBAI1018-18	Mixer Forceps Right Angle	2.5 mm × 150 mm	Straight	AISI 420 / 440A	Mirror Polish	1
19	GBAI1018-19	Tap for 4.5 mm Cortical and Shaft Screws	3.2 mm	Straight	AISI 420 / 440A	Mirror Polish	1
20	GBAI1018-20	Tap for 6.5 mm Cortical and Shaft Screws	4.5 mm	Straight	AISI 420A	Mirror Polish	1
21	GBAI1018-21	Screwdriver Hex with Holding Sleeve	6.5 mm	Straight	AISI 304 / 316L	Mirror Polish	1
22	GBAI1018-22	Double Drill Sleeve	3.5 mm	Straight	AISI 410 / 420	Mirror Polish	1
23	GBAI1018-23	Double Drill Sleeve	4.5/3.2 mm	Straight	AISI 410 / 420	Mirror Polish	1
24	GBAI1018-24	Drill Bit	6.5/3.2 mm	Straight	AISI 420 / 420J2	Mirror Polish	1
25	GBAI1018-25	Drill Bit	3.2 mm	Straight	AISI 420 / 420J2	Mirror Polish	2
26	GBAI1018-26	Guide Shaft for Coupling Screw	-----	Straight	AISI 410 / 420	Mirror Polish	2
27	GBAI1018-27	Coupling Screw for Inserting DHS Screw	-----	Straight	AISI 420 / 420J2	Mirror Polish	
						TOTAL QUANTITY	28



Elastic Nail Instruments Set(GBAI-1021)

Sr. #	Code	Instrument Description	Specification	Type	Steel Type	Finish	QTY
01	GBAI1021-01	Hammer	-----	Straight	AISI 420 / 420J2	Mirror Polish	1
02	GBAI1021-02	Locking Pliers	-----	Straight	AISI 420 / 420J2	Mirror Polish	1
03	GBAI1021-03	Awl	-----	Straight	AISI 410 / 420	Mirror Polish	1
04	GBAI1021-04	Hammer Guider	-----	Straight	AISI 410 / 420	Mirror Polish	1
05	GBAI1021-05	Drill Bit	2.5 mm	Straight	AISI 420 / 440A	Mirror Polish	1
06	GBAI1021-06	Drill Bit	3.5 mm	Straight	AISI 420 / 440A	Mirror Polish	1
07	GBAI1021-07	Drill Bit	2.5 mm	Straight	AISI 420 / 440A	Mirror Polish	1
08	GBAI1021-08	Nail Impactor	-----	Straight	AISI 410 / 420	Mirror Polish	1
09	GBAI1021-09	Nail Impactor	2 x 2,5 mm	Straight	AISI 410 / 420	Mirror Polish	1
10	GBAI1021-10	Nail Impactor	3 x 3.5 mm	Straight	AISI 410 / 420	Mirror Polish	1
11	GBAI1021-11	Nail Bender	4 x 4,5 mm	Straight	AISI 410 / 420	Mirror Polish	1
12	GBAI1021-12	Combined Drill Sleeve	-----	Straight	AISI 410 / 420	Mirror Polish	1
13	GBAI1021-13	TENS Nail	-----	Straight	AISI 410 / 420	Mirror Polish	1
14	GBAI1021-14	TENS Nail Introducer	5 mm	Straight	AISI 316L (Implant Grade)	AISI 316L (Implant Grade)	1
15	GBAI1021-15	Slotted Hammer	-----	Straight	AISI 410 / 420	Mirror Polish	1
16	GBAI1021-16	Broken screw extractor	-----	Straight	AISI 420 / 420J2	Mirror Polish	1
17	GBAI1021-17	Jumbo Cutter	-----	Straight	AISI 420 / 420J2	Mirror Polish	1
18	GBAI1021-18	Ram Rod and Key	-----	Straight	AISI 410 / 420	Mirror Polish	1
						TOTAL QUANTITY	18

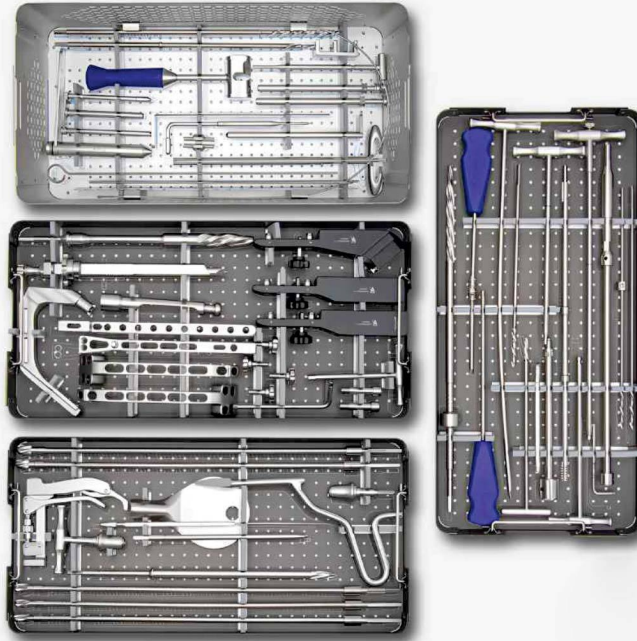

Femur Nail Instruments Set (GBAI-1023)

Sr. #	Code	Instrument Description	Specification	Type	Steel Type	Finish	QTY
01	GBAI1023-01	Mechanical Distal Jig for Femur with Handle	-----	Straight	AISI 420 / 420J2	Mirror Polish	1
02	GBAI1023-02	Mechanical Distal Jig for Tibia with Handle	-----	Straight	AISI 420 / 420J2	Mirror Polish	1
03	GBAI1023-03	Spanner	17 mm	Straight	AISI 410 / 420	Mirror Polish	1
04	GBAI1023-04	Proximal Jig Common for Tibia and Femur	-----	Straight	AISI 410 / 420	Mirror Polish	1
05	GBAI1023-05	Nail Holding Bolt	-----	Straight	AISI 420 / 420J2	Mirror Polish	1
06	GBAI1023-06	Ram	-----	Straight	AISI 420 / 420J2	Mirror Polish	1
07	GBAI1023-07	Guide Rod Cannulated	-----	Straight	AISI 316L (Implant Grade)	Satin / Passivated	1
08	GBAI1023-08	Driving Head	-----	Straight	AISI 410 / 420	Mirror Polish	1
09	GBAI1023-09	Holding Forceps for Guide Wire	-----	Straight	AISI 410 / 420	Mirror Polish	1
10	GBAI1023-10	Drill Sleeve for 3.2 mm Drill Bit	-----	Straight	AISI 410 / 420	Mirror Polish	1
11	GBAI1023-11	Protection Sleeve	3.2 mm	Straight	AISI 410 / 420	Mirror Polish	1
12	GBAI1023-12	Trocar	-----	Straight	AISI 410 / 420	Mirror Polish	1
13	GBAI1023-13	Drill Sleeve for 4 mm Drill Bit	-----	Straight	AISI 410 / 420	Mirror Polish	1
14	GBAI1023-14	Tissue Protector	4 mm	Straight	AISI 410 / 420	Mirror Polish	1
15	GBAI1023-15	Drill Bit for Jacobs Chuck	-----	Straight	AISI 410 / 420	Mirror Polish	1
16	GBAI1023-16	Drill Bit for Jacobs Chuck	3.2 mm × 250 mm	Straight	AISI 410 / 420	Mirror Polish	1
17	GBAI1023-17	Bone Awl	4 mm × 250 mm	Straight	AISI 420 / 420J2	Mirror Polish	1
18	GBAI1023-18	Screwdriver Hexagonal Extra Long, 3.5	-----	Straight	AISI 420 / 420J2	Mirror Polish	1
19	GBAI1023-19	Lucae Bayonet Forceps	3.5 mm Tip (for 4.9 mm Bolt)	Straight	AISI 420 / 440A	Mirror Polish	1
20	GBAI1023-20	Micro Alligator Ear Forceps Cup Type	110 mm (range)	Straight	AISI 420A	Mirror Polish	1
21	GBAI1023-21	Guide Wire Plain	-----	Straight	AISI 316L (Guide Wire)	Passivated Bright Finish	1
22	GBAI1023-22	Guide Wire with Ball Tip	-----	Straight	AISI 316L (Guide Wire)	Passivated Bright Finish	1
23	GBAI1023-23	Graphics Aluminium Box with Silicone Fittings	-----	-----	Aluminium Anodized (Instrument Box)	Aluminium Anodized (Instrument Box)	1
TOTAL QUANTITY							23

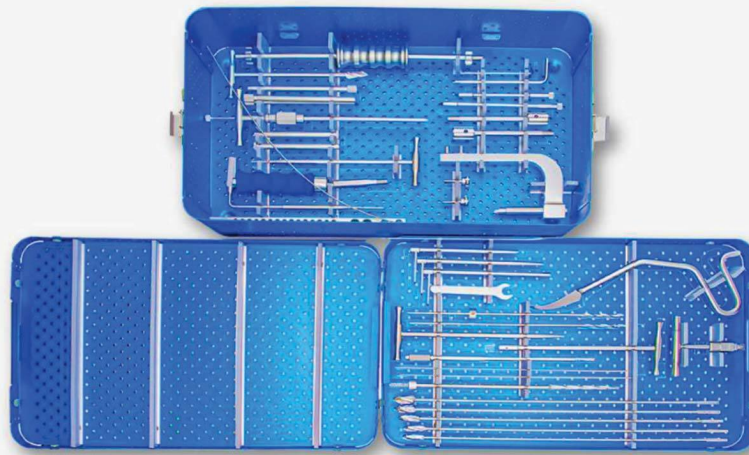

Gamma Nail Instruments Set-(GBAI-1024)

Sr. #	Code	Instrument Description	Specification	Type	Steel Type	Finish	QTY
01	GBAI1024-01	Lag Screw Step Tap	-----	Straight	AISI 420 / 440A	Mirror Polish	1
02	GBAI1024-02	Lag Screw Step Tap	-----	Straight	AISI 420 / 440A	Mirror Polish	1
03	GBAI1024-03	Distal Drill	5.5 × 220 mm	Straight	AISI 420 / 420J2	Mirror Polish	1
04	GBAI1024-04	Distal Screw Depth Gauge	-----	Straight	AISI 410 / 420	Mirror Polish	1
05	GBAI1024-05	Kirschner Wire Guide Sleeve	-----	Straight	AISI 410 / 420	Mirror Polish	1
06	GBAI1024-06	Guide Sleeve for 5.5 mm	5.5 mm	Straight	AISI 410 / 420	Mirror Polish	1
07	GBAI1024-07	Guide Sleeve for Lag Screw	-----	Straight	AISI 410 / 420	Mirror Polish	1
08	GBAI1024-08	Screw Driver for Nail Holding Bolt	-----	Straight	AISI 410 / 420	Mirror Polish	1
09	GBAI1024-09	Set Screw Driver	-----	Straight	AISI 410 / 420	Mirror Polish	1
10	GBAI1024-10	Nail Extraction Rod	-----	Straight	AISI 420 / 440A	Mirror Polish	1
11	GBAI1024-11	Distal Guide Sleeve	-----	Straight	AISI 420 / 440A	Mirror Polish	1
12	GBAI1024-12	Distal Abturator	-----	Straight	AISI 420 / 440A	Mirror Polish	1
13	GBAI1024-13	Final Impactor	-----	Straight	AISI 410 / 420	Mirror Polish	1
14	GBAI1024-14	Lag Screw Length Gauge	-----	Straight	AISI 410 / 420	Mirror Polish	1
15	GBAI1024-15	Hartmann Alligator Forceps	-----	Straight	AISI 410 / 420	Mirror Polish	1
16	GBAI1024-16	Hartmann Forceps, Round Cup	-----	Straight	AISI 410 / 420	Mirror Polish	1
17	GBAI1024-17	Nail Holding Bolt	-----	Straight	AISI 420 / 420J2	Mirror Polish	1
18	GBAI1024-18	Awl for Distal Screw	-----	Straight	AISI 420 / 420J2	Mirror Polish	1
19	GBAI1024-19	Awl for Lag Screw	-----	Straight	AISI 420 / 440A	Mirror Polish	1
20	GBAI1024-20	Micro Alligator Ear Forceps Cup Type	-----	Straight	AISI 420A	Mirror Polish	1
21	GBAI1024-21	Knife Rochester-Pean	-----	Straight	Carbon Fiber	Matte Black Carbon Fiber (Non-Reflective)	1
22	GBAI1024-22	Distal Screw Driver-Recovered	-----		AISI 420 / 420J2	Mirror Polish	1
23	GBAI1024-23	Chuck & Key	-----	Straight	AISI 410 / 420	Mirror Polish	1
24	GBAI1024-24	Targeting Sleeve 130°	130°	Angular (130°)	AISI 410 / 420	Mirror Polish	2
25	GBAI1024-25	Protection Sleeve for 13 mm Reamer	13 mm	Straight	AISI 410 / 420	Mirror Polish	2
26	GBAI1024-26	Ram	-----	Straight	AISI 420 / 420J2	Mirror Polish	1
27	GBAI1024-27	Extractor Rod	-----	Straight	AISI 410 / 420	Mirror Polish	1
28	GBAI1024-28	Targeting Sleeve 130°	130°	Angular (130°)	AISI 410 / 420	Mirror Polish	2
29	GBAI1024-29	Protection Sleeve for 13 mm Reamer	13 mm	Straight	AISI 410 / 420	Mirror Polish	2
30	GBAI1024-30	Hammering Device	-----	Straight	AISI 304 / 316L	Mirror Polish	1
31	GBAI1024-31	Cannulated Reamer	17 mm	Straight	AISI 420 / 440A	Mirror Polish	2
						TOTAL QUANTITY	36

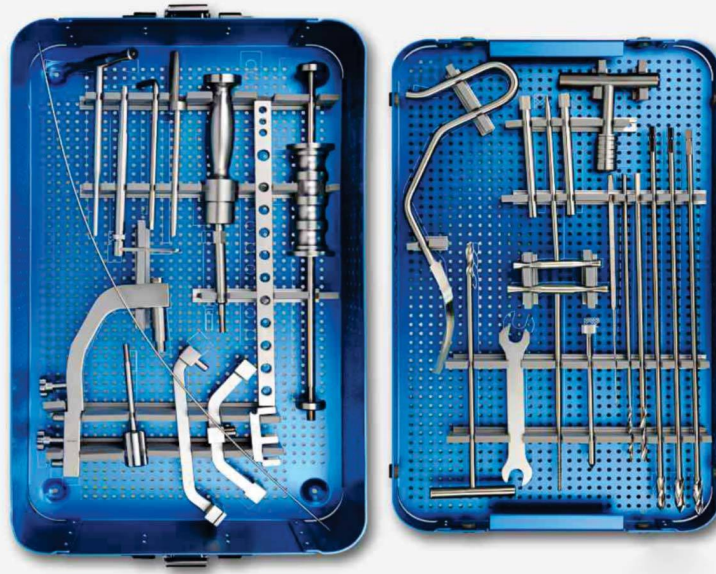

Humras Nail Instruments Set-(GBAI-1028)

Sr. #	Code	Instrument Description	Specification	Type	Steel Type	Finish	QTY
01	GBAI1028-01	Drill Bit	-----	Straight	AISI 420 / 440A	Mirror Polish	1
02	GBAI1028-02	Tap	-----	Straight	AISI 420 / 440A	Mirror Polish	1
03	GBAI1028-03	Distal Positioning Frame	5.5 × 220 mm	Straight	AISI 420 / 420J2	Mirror Polish	1
04	GBAI1028-04	Open Wrench	-----	Straight	AISI 410 / 420	Mirror Polish	1
05	GBAI1028-05	Depth Gauge	-----	Straight	AISI 410 / 420	Mirror Polish	1
06	GBAI1028-06	Drill Bit	5.5 mm	Straight	AISI 410 / 420	Mirror Polish	1
07	GBAI1028-07	Drill Bit	-----	Straight	AISI 410 / 420	Mirror Polish	1
08	GBAI1028-08	Reamer	-----	Straight	AISI 410 / 420	Mirror Polish	1
09	GBAI1028-09	Reamer	-----	Straight	AISI 410 / 420	Mirror Polish	1
10	GBAI1028-10	Sleeve	-----	Straight	AISI 420 / 440A	Mirror Polish	1
11	GBAI1028-11	Awl	-----	Straight	AISI 420 / 440A	Mirror Polish	1
12	GBAI1028-12	Screwdriver SW2.5	-----	Straight	AISI 420 / 440A	Mirror Polish	1
13	GBAI1028-13	Quick Coupling T-Handle	-----	Straight	AISI 410 / 420	Mirror Polish	1
14	GBAI1028-14	Sighting Device Handle	-----	Straight	AISI 410 / 420	Mirror Polish	1
15	GBAI1028-15	Nail Connector	-----	Straight	AISI 410 / 420	Mirror Polish	1
16	GBAI1028-16	Proximal Guider	-----	Straight	AISI 410 / 420	Mirror Polish	1
17	GBAI1028-17	Distal Guider	-----	Straight	AISI 420 / 420J2	Mirror Polish	1
18	GBAI1028-18	Fixed Connector	-----	Straight	AISI 420 / 420J2	Mirror Polish	1
19	GBAI1028-19	Location Road	-----	Straight	AISI 420 / 440A	Mirror Polish	1
20	GBAI1028-20	Drill Sleeve	-----	Straight	AISI 420A	Mirror Polish	1
21	GBAI1028-21	Hex Wrench	-----	Straight	Carbon Fiber	Matte Black Carbon Fiber (Non-Reflective)	1
22	GBAI1028-22	Gauge Cannula	-----		AISI 420 / 420J2	Mirror Polish	1
23	GBAI1028-23	Guide Rod	-----	Straight	AISI 410 / 420	Mirror Polish	1
24	GBAI1028-24	Universal Joint	130°	Angular (130°)	AISI 410 / 420	Mirror Polish	2
25	GBAI1028-25	Universal Joint	-----	Articulated Type	AISI 304	Polished	1
26	GBAI1028-26	Hammer	20 cm	Straight	AISI 410	Satin	1
27	GBAI1028-27	Guide Wire	2.5 mm × 300 mm	Straight	AISI 304	Smooth	1
28	GBAI1028-28	Aluminum Box	-----	-----	Aluminium	Anodized Polished	1
TOTAL QUANTITY							28



Interlocking Nail Instrument Set-(GBAI-1029)

Sr. #	Code	Instrument Description	Specification	Type	Steel Type	Finish	QTY
01	GBAI1029-01	Mechanical Distal Jig for Tibia with Handle	-----	Straight	AISI 420	Satin	1
02	GBAI1029-02	Mechanical Distal Jig for Femur with Handle	-----	Straight	AISI 420	Satin	1
03	GBAI1029-03	Spanner	17 mm	Straight	AISI 304	Mirror	1
04	GBAI1029-04	Proximal Jig Common for Tibia and Femur	-----	Straight	AISI 420	Satin	1
05	GBAI1029-05	Guide Rod (Cannulated)	30 mm	Straight	AISI 410	Satin	1
06	GBAI1029-06	Nail Holding Bolt	-----	Straight	AISI 410	Satin	1
07	GBAI1029-07	Holding Forceps for Guide Wire	20 cm	Straight	AISI 410	Satin	1
08	GBAI1029-08	Driving Head	-----	Straight	AISI 410	Satin	1
09	GBAI1029-09	Holding Forceps for Guide Wire	20 cm	Straight	AISI 410	Satin	1
10	GBAI1029-10	Drill Sleeve for 3.2 mm Drill Bit	3.2 mm	Straight	AISI 410	Satin	1
11	GBAI1029-11	Trocar	15 cm	Straight Sharp Tip	AISI 420	Satin	1
12	GBAI1029-12	Protection Sleeve	-----	Straight	AISI 410	Satin	1
13	GBAI1029-13	Tissue Protector	-----	Straight	AISI 420	Satin	1
14	GBAI1029-14	Dressing Forceps	4 cm	Straight	AISI 410	Satin	1
15	GBAI1029-15	Bone Awl	20 cm	Straight	AISI 410	Satin	1
16	GBAI1029-16	Drill Bit for Jacobs Chuck	3.2 × 250 mm	Straight	AISI 420	Mirror	1
17	GBAI1029-17	Drill Bit for Jacobs Chuck	4 × 250 mm	Straight	AISI 410	Mirror	1
18	GBAI1029-18	Screwdriver Hexagonal Extra Long	3.5 mm Tip	Straight	AISI 410	Satin	1
19	GBAI1029-19	Dressing Forceps	Measuring up to 110 mm	Straight	AISI 304	Polished	1
20	GBAI1029-20	Crile Hemostatic Forceps	-----	-----	AISI 304	Polished	1
21	GBAI1029-21	Guide Wire (Plain)	2.5 mm × 300 mm	Straight	AISI 304	Polished	1
22	GBAI1029-22	Guide Wire (with Ball Tip)	2.5 mm × 300 mm	Straight	AISI 304	Polished	1
23	GBAI1029-23	Graphics Aluminium Box with Silicone Fittings	-----	Straight	Aluminium	-----	1
TOTAL QUANTITY							23



Large Fragment Set-(GBAI-1032)

Sr. #	Code	Instrument Description	Specification	Type	Steel Type	Finish	QTY
01	GBAI1032-01	Allen Key for Drill Bit Stopper	3 mm	Straight (Hex Type)	AISI 304	Satin	1
02	GBAI1032-02	Depth Gauge (Measuring Range up to 110 mm)	10 mm	Straight	AISI 304	Satin	1
03	GBAI1032-03	Countersink for 4.5 / 6.5 mm Screws	-----	Straight (Conical Head)	AISI 420	Mirror	1
04	GBAI1032-04	Double Drill Sleeve (Universal)	3.2 / 4.5 mm	Straight	AISI 410	Satin	1
05	GBAI1032-05	Double Drill Sleeve (Universal)	3.2 / 6.5 mm	Straight	AISI 410	Satin	1
06	GBAI1032-06	Guide Sleeve for 2 mm K-Wires	2 mm	Straight	AISI 410	Mirror	41
07	GBAI1032-07	Guide Wire Threaded Trocar	2 mm x 280 mm	Straight	AISI 420	Satin	5
08	GBAI1032-08	Drill Bit (Quick Coupling)	3.2 x 130 mm	Straight	AISI 410	Satin	2
09	GBAI1032-09	Drill Bit (Quick Coupling)	4.5 x 130 mm	Straight	AISI 420	Satin	2
10	GBAI1032-10	Drill Bit with Stopper (Quick Coupling)	4.3 x 220 mm	Straight	AISI 410	Satin	2
11	GBAI1032-11	Drill Bit with Stopper (Quick Coupling)	4.5 mm	Straight	AISI 420	Satin	1
12	GBAI1032-12	Hohmann Retractor	25mm	Curved	AISI 410	Satin	2
13	GBAI1032-13	Insert Drill Sleeve	4.5 / 3.2 mm	Straight	AISI 410	Satin	1
14	GBAI1032-14	Periosteal Elevator (Fiber Handle)	5 mm	Straight	AISI 420	Satin	1
15	GBAI1032-15	Periosteal Elevator (Fiber Handle)	10 mm	Straight	Fiber Reinforced Handle	Mat	1
16	GBAI1032-16	Joseph Double Skin Hook Larger	-----	Flat Template Type	Fiber Reinforced Handle	Mat	3
17	GBAI1032-17	Castroviejo Caliper	20 cm	Straight	AISI 410	Satin	2
18	GBAI1032-18	Reduction Forceps (Pointed, Ratchet Lock)	20 cm	Straight	AISI 410	Satin	1
19	GBAI1032-19	Reduction Forceps (Pointed, Ratchet Lock)	20 cm	Straight	AISI 410	Satin	1
20	GBAI1032-20	Gillies Skin Hooks 4mm	25 cm	Straight	AISI 410	Satin	2
21	GBAI1032-21	Screw Extraction T-Handle (for 5 mm Screws)	-----	T-Type	AISI 410	Satin	1
22	GBAI1032-22	Screwdriver Hexagonal with Holding Sleeve	3.5 mm Tip	Straight	AISI 410	Satin	1
23	GBAI1032-23	Screwdriver Torque (for 5 mm Locking Screws)	-----	Straight	AISI 410	Satin	1
24	GBAI1032-24	Screw Holding Forceps	20 cm	Straight	AISI 410	Satin	1

Large Fragment Set-(GBAI-1032)

Sr. #	Code	Instrument Description	Specification	Type	Steel Type	Finish	QTY
25	GBAI1032-25	Screwdriver Quick Coupling (for 5 mm & 4.5 mm Screws)	-----	Straight	AISI 410	Satin	1
26	GBAI1032-26	T-Handle (Quick Coupling Type)	-----	T-Type	AISI 410	Satin	1
27	GBAI1032-27	Adson Sharp Hook	14 cm	Straight	AISI 410	Satin	1
28	GBAI1032-28	Tap (Quick Coupling)	14.5 cm	Straight	AISI 410	Satin	1
29	GBAI1032-29	Tap (Quick Coupling)	6.5 mm	Straight	AISI 410	Satin	1
30	GBAI1032-30	Threaded Drill Guide (for 4.3 mm Drill Bit)	5 mm	Straight	AISI 304	Anodized Polished	3
31	GBAI1032-31	Trephine T-Handle	-----	T-Type	Aluminium	-----	1
32	GBAI1032-32	Graphics Aluminium Box with Silicone Fittings	-----	-----	-----	- ----	1
TOTAL QUANTITY							46



Small Fragment Set-(GBAI-1043)

Sr. #	Code	Instrument Description	Specification	Type	Steel Type	Finish	QTY
01	GBAI1043-01	Drill Bit	2.5 mm Dia	Straight	AISI 420	Satin	2
02	GBAI1043-02	Drill Bit	3.5 mm Dia	Straight	AISI 420	Satin	2
03	GBAI1043-03	Tap for 3.5 mm Cortical Screw	3.5 mm	Straight	AISI 420	Mirror	2
04	GBAI1043-04	Tap for 4.5 mm Cortical Screw	4.0 mm	Straight	AISI 420	Mirror	2
05	GBAI1043-05	Countersink for 3.5 / 4.0 mm Screws (6.0 mm Head)	-----	Straight	AISI 420	Mirror	1
06	GBAI1043-06	Quick Coupling Handle (T-Type)	-----	T-Type	AISI 410	Matte	1
07	GBAI1043-07	Combined Drill & Tap Sleeve	3.5 / 2.5 mm	Straight	AISI 420	Satin	1
08	GBAI1043-08	Insert Drill Sleeve	2.5 / 3.5 mm	Straight	AISI 420	Satin	1
09	GBAI1043-09	Holding Forceps for Guide Wire	2.5 mm Tip	Straight	AISI 420	Satin	1
10	GBAI1043-10	Drill Sleeve for 3.2 mm Drill Bit	2.5 mm Tip	Straight	AISI 420	Satin	1
11	GBAI1043-11	Sharp Hook	14 cm	Straight Sharp Tip	AISI 420	Mirror	1
12	GBAI1043-12	Depth Gauge (Small)	110 mm Range	Straight	AISI 420	Mirror	1
13	GBAI1043-13	Plate Bender (for 2.7 & 3.5 mm Plates)	-----	Flat Type	AISI 410	Satin	1
14	GBAI1043-14	Self-Centering Bone Holding Forceps	19 cm	Straight	AISI 420	Satin	1
15	GBAI1043-15	Hohmann Retractor (Small, 8 mm Wide)	16 cm	Straight	AISI 420	Mirror	2
16	GBAI1043-16	Periosteal Elevator (Straight/Curved Tip)	12 mm Wide	Straight / Curved	AISI 420	Mirror	1
17	GBAI1043-17	Hohmann Retractor (15 mm Wide)	16 cm	Straight	AISI 420	Mirror	2
18	GBAI1043-18	Reduction Forceps (Serrated Jaw)	14 cm	Straight	AISI 420	Satin	1
19	GBAI1043-19	Reduction Forceps (Pointed Jaw)	14 cm	Straight	AISI 420	Mirror	1
20	GBAI1043-20	Drill Guide (Neutral & Load Position, Small)	-----	Straight	AISI 420	Satin	1
21	GBAI1043-21	Instrument Container (Empty)	-----	-----	AISI 304	Matte	1
TOTAL QUANTITY							27



Orthopedic Instruments Set-(GBAI-1040)

Sr. #	Code	Instrument Description	Specification	Type	Steel Type	Finish	QTY
01	GBAI1040-01	Steel Ruler	15 cm (6")	Straight	AISI 304	Satin	1
02	GBAI1040-02	Volkman Retractor (One Sharp Prong)	21.5 cm (8½")	Rake Type	AISI 420	Mirror	2
03	GBAI1040-03	Frazier Suction Tube	8 Fr	Curved	AISI 410	Mirror	1
04	GBAI1040-04	Frazier Suction Tube	12 Fr	Curved	AISI 420	Satin	1
05	GBAI1040-05	Beyer-Stille Rongeur (4×15 mm Bite)	18 cm (7")	Curved	AISI 420	Satin	1
06	GBAI1040-06	Ruskin Bone Cutting Forceps (Angled Jaw)	19 cm (7½")	Angled	AISI 420	Satin	1
07	GBAI1040-07	Schmidt Tonsil Hemostatic Forceps (Slight Curve)	19 cm (7½")	Curved	AISI 420	Satin	1
08	GBAI1040-08	Stille Luer Rongeur (10 mm Bite, Double Action)	21.5 cm (8½")	Curved	AISI 420	Satin	1
09	GBAI1040-09	Kern Bone Holding Forceps (Without Ratchet)	21.5 cm (8½")	Straight	AISI 410	Satin	2
10	GBAI1040-10	Lowman Bone Clamp (1×2 Jaws, Max 1")	13 cm (5")	Straight	AISI 410	Satin	1
11	GBAI1040-11	Lowman Bone Clamp (1×2 Jaws, Max 2½")	15 cm	Straight	AISI 420	Satin	1
12	GBAI1040-12	Lambotte Bone Holding Forceps (Swivel Head, Ratchet)	27 cm (10½")	Adjustable	AISI 410	Satin	1
13	GBAI1040-13	Lane Bone Forceps (2×2 Teeth, Ratchet)	33 cm (13"), 34 mm Opening	Straight	AISI 420	Satin	1
14	GBAI1040-14	Ferguson Angiotribe Forceps	16.5 cm (6½")	Straight	AISI 410	Satin	6
15	GBAI1040-15	Hibbs Osteotome	23 cm (9"), 6 mm	Straight	AISI 410	Satin	1
16	GBAI1040-16	Hibbs Osteotome	23 cm (9"), 10 mm	Curved	AISI 410	Mirror	1
17	GBAI1040-17	Hibbs Osteotome	23 cm (9"), 13 mm	Straight	AISI 410	Mirror	1
18	GBAI1040-18	Hibbs Osteotome	23 cm (9"), 16 mm	Curved	AISI 410	Mirror	1
19	GBAI1040-19	Hibbs Osteotome	23 cm (9"), 19 mm	Straight	AISI 410	Mirror	1
20	GBAI1040-20	Hibbs Osteotome	23 cm (9"), 25 mm	Curved	AISI 410	Mirror	1
21	GBAI1040-21	Hibbs Osteotome	23 cm (9"), 29 mm	Straight	AISI 410	Mirror	1
22	GBAI1040-22	Hibbs Gouge	24 cm (9½"), 6 mm	Straight	AISI 304	Mirror	1
23	GBAI1040-23	Hibbs Gouge	24 cm (9½"), 10 mm	Curved	AISI 420	-----	1
24	GBAI1040-24	Mayo-Hegar Needle Holder (TC Serrated)	20 cm (8")	Straight	AISI 420	Mirror	1

Orthopedic Instruments Set-(GBAI-1040)

Sr. #	Code	Instrument Description	Specification	Type	Steel Type	Finish	QTY
25	GBAI1040-25	Mayo Scissors (TC Curved)	14 cm (5½")	Straight	AISI 420	Mirror	1
26	GBAI1040-26	Mayo Scissors (TC Curved)	17 cm (6¾")	Straight	AISI 420	Mirror	1
27	GBAI1040-27	Mayo Scissors (TC Curved)	13 cm	Straight	AISI 410	Satin	1
28	GBAI1040-28	Knife Handle No. 3	13 cm	Straight	AISI 410	Satin	1
29	GBAI1040-29	Knife Handle No. 4	18 cm (7")	Curved	AISI 420	Satin	1
30	GBAI1040-30	Metzenbaum Scissors (TC, Straight)	15 cm (6")	Straight	AISI 420	Mirror	2
31	GBAI1040-31	Esmarch Plaster Shears	20 cm (8")	Straight	AISI 420	Mirror	1
32	GBAI1040-32	Adson Forceps (1×2 Teeth, Delicate)	16 cm (6¼")	Angled	AISI 420	Mirror	1
33	GBAI1040-33	Tissue Forceps (4×5 Teeth)	20 cm (8")	Straight	AISI 420	Mirror	2
34	GBAI1040-34	Babcock Intestinal Forceps	15 cm (6")	Straight	AISI 420	Satin	1
35	GBAI1040-35	Allis Tissue Forceps 4×5 Teeth	15 cm (6")	Straight	AISI 420	Satin	4
36	GBAI1040-36	Allis Tissue Forceps 4×5 Teeth	12 cm (4¾")	Straight	AISI 420	Satin	6
37	GBAI1040-37	Backhaus Towel Clamps	12 cm (4¾")	Straight	AISI 420	Mirror	8
38	GBAI1040-38	Adson Forceps Serrated	13 cm (5¼")	Straight	AISI 410	Satin	1
39	GBAI1040-39	Metzenbaum Scissors	21.5 cm (8½")	Straight	AISI 410	Mirror	1
40	GBAI1040-40	Meyerdig Retractor (Large 3½" × 2")	24 cm (9½")	Angled	AISI 420	Mirror	1
41	GBAI1040-41	Meyerdig Retractor (Small 2" × ¾")	24 cm (9½")	Angled	AISI 420	Satin	1
42	GBAI1040-42	Israel Retractor (4 Blunt Prongs, 1½" × 1¾")	23 cm (9")	Rake Type	AISI 420	Satin	1
43	GBAI1040-43	Volkman Retractor (4 Sharp Prongs)	22 cm (8¾")	Rake Type	AISI 420	Satin	1
44	GBAI1040-44	Volkman Retractor (4 Sharp Prongs)	22 cm (8¾")	Rake Type	AISI 420	Satin	2
45	GBAI1040-45	Hibbs Retractor (1" × 3" Blade)	23.5 cm (9¼")	Straight	AISI 420	Satin	1
46	GBAI1040-46	Beckman Retractor (Hinged 4×4 Teeth, Sharp)	32 cm (12½")	Hinged	AISI 420	Satin	1
47	GBAI1040-47	Bennett Tibia Retractor (Small)	24 cm (9½")	Straight	AISI 420	Mirror	1
48	GBAI1040-48	Bennett Tibia Retractor (Large)	24 cm (9½")	Straight	AISI 420	-----	1
TOTAL QUANTITY							73



Minor Orthopedic Instrument Set-(GBAI-1038)

Sr. #	Code	Instrument Description	Specification	Type	Steel Type	Finish	QTY
01	GBAI1038-01	Scalpel Handle #3	12 cm (4¾")	Straight	AISI 410	Mirror	2
02	GBAI1038-02	Scalpel Handle #4	13 cm (5")	Straight	AISI 410	Satin	2
03	GBAI1038-03	Steel Ruler	15 cm (6")	Straight	AISI 410	Satin	1
04	GBAI1038-04	Stevens Tenotomy Scissors, Supercut, Blunt/Blunt	14 cm (5½")	Curved	AISI 410	Mirror	1
05	GBAI1038-05	Lister Bandage Scissors, Supercut	15 cm (5¾")	Straight	AISI 410	Mirror	1
06	GBAI1038-06	Mayo Scissors, Supercut, Serrated	17 cm (6¾")	Curved	AISI 410	Mirror	1
07	GBAI1038-07	Metzenbaum Scissors, Supercut, Serrated	18 cm (7")	Curved	AISI 410	Satin	1
08	GBAI1038-08	Operating Scissors, Supercut, Sharp/Blunt	12.5 cm (5")	Straight	AISI 410	Mirror	1
09	GBAI1038-09	Halsted Mosquito Forceps	9 cm (3½")	Curved	AISI 410	Mirror	6
10	GBAI1038-10	Halsted Mosquito Forceps	9 cm (3½")	Straight	AISI 410	Satin	6
11	GBAI1038-11	Kelly Forceps	14 cm (5½")	Straight	AISI 410	Satin	12
12	GBAI1031-12	Kelly Forceps	14 cm (5½")	Curved	AISI 410	Satin	6
13	GBAI1038-13	Senn-Miller Retractor (3-Prong Sharp)	16 cm (6¼")	Curved	AISI 410	Satin	6
14	GBAI1038-14	Rochester-Ochsner Forceps (1x2 Teeth)	20 cm (8")	Straight	AISI 410	Satin	2
15	GBAI1038-15	Rochester-Ochsner Forceps (1x2 Teeth)	16 cm (6¼")	Curved	AISI 410	Satin	2
16	GBAI1038-16	Jansen Mastoid Retractor 3x3 Teeth	16 cm (6¼")	Straight	AISI 410	Satin	2
17	GBAI1038-17	Dressing Forceps (Serrated)	20 cm (8")	Curved	AISI 410	Satin	2
18	GBAI1038-18	Dressing Forceps (Serrated)	14 cm (5½")	Straight	AISI 410	Satin	2
19	GBAI1038-19	Gemini Mixer (Delicate, Full Curved Jaws)	20 cm (8")	Curved	AISI 410	Mirror	2
20	GBAI1038-20	Tissue Forceps (1x2 Teeth)	14 cm (5½")	Straight	AISI 410	Mirror	2
21	GBAI1038-21	Tissue Forceps (1x2 Teeth)	15 cm (6")	Straight	AISI 410	Mirror	2
22	GBAI1038-22	Tissue Forceps (1x2 Teeth)	20 cm (8")	Straight	AISI 410	Mirror	2
23	GBAI1038-23	TC Baby Crile-Wood Needle Holder, Serrated	15 cm (6")	Straight	AISI 410	Mirror	2
24	GBAI1038-24	TC Mayo-Hegar Needle Holder, Serrated	15 cm (6")	Straight	AISI 410 / Tungsten Carbide Inserts	Mirror	4

Minor Orthopedic Instrument Set-(GBAI-1038)

Sr. #	Code	Instrument Description	Specification	Type	Steel Type	Finish	QTY
25	GBAI1038-25	Meyering Retractor "A", Angled	18 cm (7")	Angled	AISI 420	Mirror	1
26	GBAI1038-26	Meyering Retractor "B", Angled 3 Teeth	18 cm (7")	Angled	AISI 210	Mirror	1
27	GBAI1038-27	Meyering Retractor "C", Angled 3 Teeth	18 cm (7")	Angled	AISI 210	Mirror	1
28	GBAI1038-28	Meyering Retractor "D", Angled 3 Teeth	18 cm (7")	Angled	AISI 420	Mirror	1
29	GBAI1038-29	Meyering Retractor "E", Angled 3 Teeth	18 cm (7")	Curved	AISI 420	Mirror	1
30	GBAI1038-30	Meyering Retractor "F", Angled 3 Teeth	18 cm (7")	Curved	AISI 420	Mirror	1
31	GBAI1038-31	Gelpi Retractor (Sharp 2-Prong)	15 cm (6")	Self-Retaining	AISI 420	Mirror	1
32	GBAI1038-32	Gelpi Retractor (Sharp 2-Prong)	16 cm (6¼")	Self-Retaining	AISI 420	Mirror	2
33	GBAI1038-33	Babcock Intestinal Forceps	20 cm (8")	Self-Retaining	AISI 410	Mirror	1
34	GBAI1038-34	Babcock Intestinal Forceps	15 cm (6")	Angled	AISI 410	Satin	1
35	GBAI1038-35	Allis Tissue Forceps 4x5 Teeth	18.5 cm (7¼"), 5 mm Bite	Straight	AISI 410	Satin	1
36	GBAI1038-36	Allis Tissue Forceps 4x5 Teeth	14 cm (5½"), 4 mm	Straight	AISI 410	Satin	1
37	GBAI1025-37	Backhaus Towel Clamps	14 cm (5½"), 6 mm	Straight	AISI 410	Satin	1
38	GBAI1038-38	Adson Forceps Serrated	14 cm (5½"), 8 mm	Straight	AISI 410	Satin	1
39	GBAI1038-39	Hoke Osteotome	14 cm (5½"), 10 mm	Straight	AISI 410	Satin	1
40	GBAI1038-40	Hoke Osteotome	14 cm (5½"), 13 mm	Straight	AISI 410	Satin	1
41	GBAI1038-41	Hoke Osteotome	14 cm (5½"), 16 mm	Straight	AISI 410	Satin	1
42	GBAI1038-42	Hoke Osteotome	27 cm (10½"), 900 g (32 oz)	Straight	AISI 410	Satin	1
43	GBAI1038-43	Bruns Bone Curette #0 (Oval Cup)	17 cm (6¾")	Straight	AISI 420	Satin	1
44	GBAI1038-44	Bruns Bone Curette #1 (Oval Cup)	17 cm (6¾")	Straight	AISI 420	Mirror	1
45	GBAI1025-45	Bruns Bone Curette #2 (Oval Cup)	17 cm (6¾")	Straight	AISI 420	Mirror	1
46	GBAI1038-46	Bruns Bone Curette #3 (Oval Cup)	17 cm (6¾")	Straight	AISI 420	Mirror	1
47	GBAI1038-47	Adson Tissue Forceps (Delicate 1x2 Teeth)	12 cm (4¾")	Straight	AISI 420	Mirror	2
48	GBAI1038-48	Adson-Brown Tissue Forceps (9x9 Teeth)	12 cm (4¾")	Straight	AISI 420	Mirror	2
49	GBAI1038-49	Freer Elevator (Double End, Sharp/Blunt)	18.5 cm (7¼")	Double-Ended	AISI 410	Mirror	6
50	GBAI1038-50	Joseph Hook (Single Sharp Prong)	16 cm (6¼")	Straight	AISI 420	Mirror	6
51	GBAI1038-51	Joseph Hook (Double Sharp Prongs, 5 mm)	16 cm (6¼")	Straight	AISI 420	Mirror	2
52	GBAI1038-52	Backhaus Towel Clamp (Satin Finish)	13 cm (5¼")	Straight	AISI 420	Mirror	1
53	GBAI1038-53	Backhaus Towel Clamp (Small)	9 cm (3½")	Curved	AISI 420	Mirror	1
54	GBAI1038-54	Cushing Nerve & Vein Retractor	23 cm (9")	Curved	AISI 420	Mirror	1
55	GBAI1038-55	Frazier Suction Tube (Curved, 7 Fr)	7 Fr	Curved	AISI 420	Mirror	1
56	GBAI1038-56	Frazier Suction Tube (Curved, 8 Fr)	8 Fr	Curved	AISI 420	Mirror	1
57	GBAI1038-57	Richardson Retractor (Small, Grip Handle)	24 cm (9½")	Curved	AISI 420	Mirror	1
58	GBAI1038-58	Richardson Retractor (Medium, Grip Handle)	24 cm (9½")	Curved	AISI 420	Mirror	1
59	GBAI1038-59	Richardson Retractor (Large, Grip Handle)	24 cm (9½")	Curved	AISI 420	Mirror	1
60	GBAI1038-60	Richardson Retractor (Extra Large, Grip Handle)	21 cm (8¼")	Curved	AISI 420	Mirror	1
61	GBAI1038-61	U.S. Army Retractor (Set of 2, Double Ended)	25 cm (10")	Double-Ended	AISI 410	Mirror	2
62	GBAI1038-62	Deaver Retractor #0 (Grip Handle 1")	21.5 cm (8½")	Curved	AISI 410	Mirror	2
63	GBAI1038-63	Volkman Retractor (Ring Handle, 3 Prongs, Sharp)	21.5 cm (8½")	Rake Type	AISI 410	Satin	1
64	GBAI1038-64	Volkman Retractor (Ring Handle, 2 Prongs, Sharp)	2 x 18 cm (¾" x 7")	Rake Type	AISI 420	Satin	1
65	GBAI1038-65	Penn Retractor (Double Ended, Sharp, 3 Prong)	16 cm (6¼")	Double-Ended	AISI 420	Satin	2
66	GBAI1038-66	Alm Retractor (Self-Retaining, Blunt, 4x4 Teeth)	10 cm (4")	Self-Retaining	AISI 420	Mirror	1
67	GBAI1038-67	Foerster Sponge Forceps (Straight, Serrated, Satin Finish)	24 cm (9½")	Straight	AISI 420	Mirror	6
						TOTAL QUANTITY	141

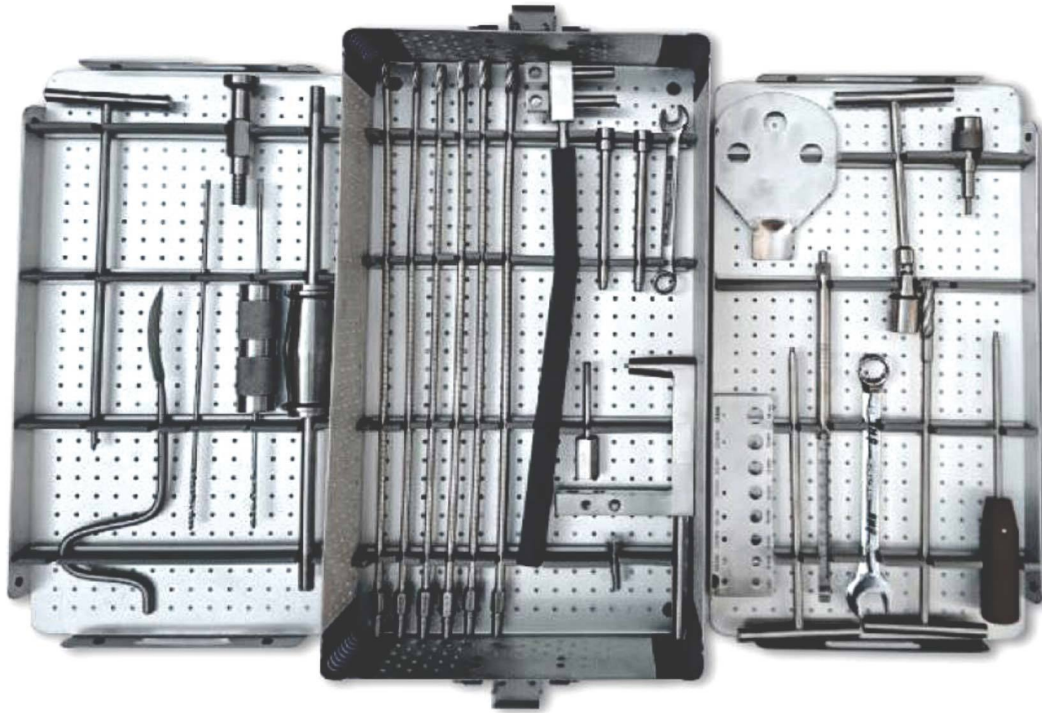

Tibia Nail Instruments set-(GBAI-1050)

Sr. #	Code	Instrument Description	Specification	Type	Steel Type	Finish	QTY
01	GBAI1050-01	Proximal Knife Rod T-Handle	-----	T-Handle	AISI 420	Mirror	1
02	GBAI1050-02	Proximal Knife Rod	φ12 / φ3.2	Straight	AISI 420	Mirror	1
03	GBAI1050-03	Cannulated Awl	φ3.2	Straight	AISI 410	Satin	1
04	GBAI1050-04	Right Angle Locking Rod	-----	Right-Angled	AISI 410	Satin	1
05	GBAI1050-05	Nail Driver Extractor Connector	-----	Connector Type	AISI 420	Mirror	1
06	GBAI1050-06	Wrench	Standard	Straight	AISI 410	Satin	1
07	GBAI1050-07	Protection Sleeve	φ12	Straight	AISI 410	Satin	1
08	GBAI1050-08	Stille Connector Wrench	-----	T-Type	AISI 410	Satin	1
09	GBAI1050-09	Positioning Rod Sleeve	φ3.2	Straight	AISI 410	Satin	1
10	GBAI1050-10	Frame Rods Locking Screwdriver	Sw5	Straight	AISI 410	Satin	1
11	GBAI1050-11	Drill Stopper Screwdriver	Sw3	Straight	AISI 410	Satin	1
12	GBAI1050-12	Cancellous Screw Drill Sleeve Set	φ3.2 / 8.6 / 11	Straight	AISI 410	Satin	1
13	GBAI1050-13	Lane Bone Forceps (2x2 Teeth, Ratchet)	φ4.0	Straight	AISI 420	Mirror	1
14	GBAI1050-14	Ferguson Angiotribe Forceps	-----	Straight	AISI 410	Mirror	1
15	GBAI1050-15	Trocar	-----	Straight	AISI 410	Satin	1
16	GBAI1050-16	Nail Extract Connecting Rod	-----	Straight	AISI 410	Satin	1
17	GBAI1050-17	Compression Bolt	-----	Straight	AISI 410	Satin	1
18	GBAI1050-18	Bone Drill	φ3.2	Straight	AISI 410	Satin	1
19	GBAI1050-19	Drill Stopper	Standard	Straight	AISI 410	Satin	1
20	GBAI1050-20	Hex Screw Holder	φ5.2	Straight	AISI 410	Satin	1
21	GBAI1050-21	Connecting Rod Universal Driver	φ5.2	Straight	AISI 410	Satin	1
22	GBAI1050-22	Locking Screw Driver	Standard	Straight	AISI 420	Mirror	1
23	GBAI1050-23	Protection Plate	Standard	Straight	AISI 420	Mirror	1
24	GBAI1050-24	Guide Pin	-----	Straight	AISI 410	Satin	1

Tibia Nail Instruments set-(GBAI-1050)

Sr. #	Code	Instrument Description	Specification	Type	Steel Type	Finish	QTY
25	GBAI1050-25	Guide Pin Guider	-----	Straight	AISI 410	Satin	1
26	GBAI1050-26	Bone Drill	φ4.0	Straight	AISI 410	Satin	1
27	GBAI1050-27	Drill Stopper	φ4.0	Straight	AISI 410	Satin	1
28	GBAI1050-28	Hex Screw Holder	SW3.5	Straight	AISI 420	Mirror	1
29	GBAI1050-29	Connecting Rod Universal Driver	SW6.5	Straight	AISI 420	Mirror	1
30	GBAI1050-30	Locking Screw Driver	SW3.5	Straight	AISI 420	Mirror	1
31	GBAI1050-31	Protection Plate	-----	Flat	AISI 420	Mirror	1
32	GBAI1050-32	Guide Pin	-----	Straight	AISI 410	Mirror	1
33	GBAI1050-33	Sliding Hammer	-----	Straight	AISI 420	Satin	1
34	GBAI1050-34	Frame Guide Rod	-----	Straight	AISI 420	Mirror	1
35	GBAI1050-35	Guide Pin Holder	-----	Straight	AISI 420	Mirror	1
36	GBAI1050-36	Reamer Shaft	-----	Straight	AISI 420	Mirror	1
37	GBAI1050-37	Sliding Hammer Guide Rod	-----	Straight	AISI 420	Mirror	1
38	GBAI1050-38	Developing Calculator	-----	Digital	AISI 410	Mirror	1
39	GBAI1050-39	Connecting Bolt	-----	Straight	AISI 410	Mirror	1
40	GBAI1050-40	Insertion Handle	-----	Straight / Ergonomic	AISI 420	Mirror	1
41	GBAI1050-41	U-Shaped Locking Block	SW6.5	U-Type	AISI 420	Mirror	1
42	GBAI1050-42	Connecting Rod Screwdriver	-----	Straight	AISI 420	Mirror	1
43	GBAI1050-43	Distal Target Device	φ7.5 – 12	Articulated	AISI 410	Satin	1
44	GBAI1050-44	Flexible Reamer Bit	φ12 / φ3.2	Flexible / Curved	AISI 410	Satin	1
45	GBAI1050-45	Cannulated Chisel	-----	Straight	AISI 410	Satin	1
46	GBAI1050-46	Proximal Target Device	-----	Straight	AISI 410	Satin	1
47	GBAI1050-47	Proximal Cancellous Target Device	-----	Straight	AISI 420	Mirror	1
48	GBAI1050-48	Proximal Cancellous Target Device Locking Screw	-----	Straight	AISI 420	Mirror	1
TOTAL QUANTITY							48

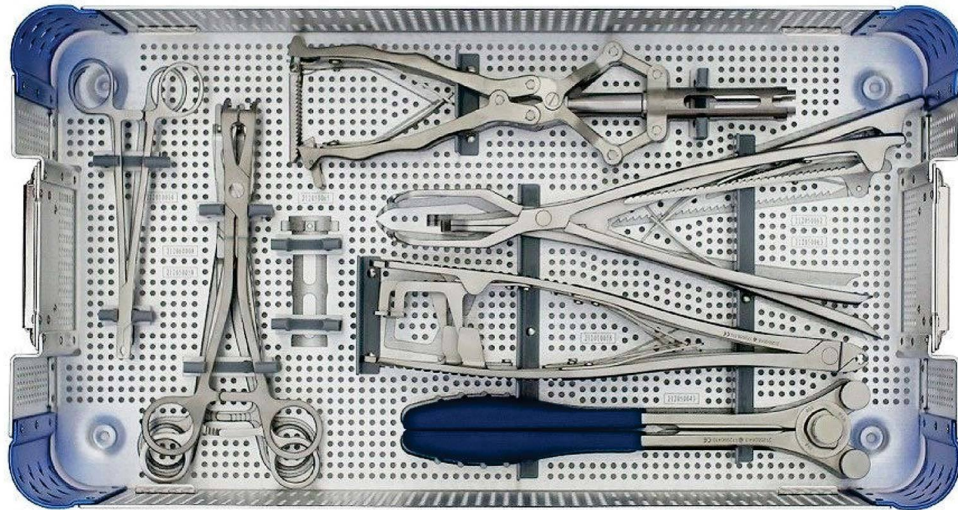
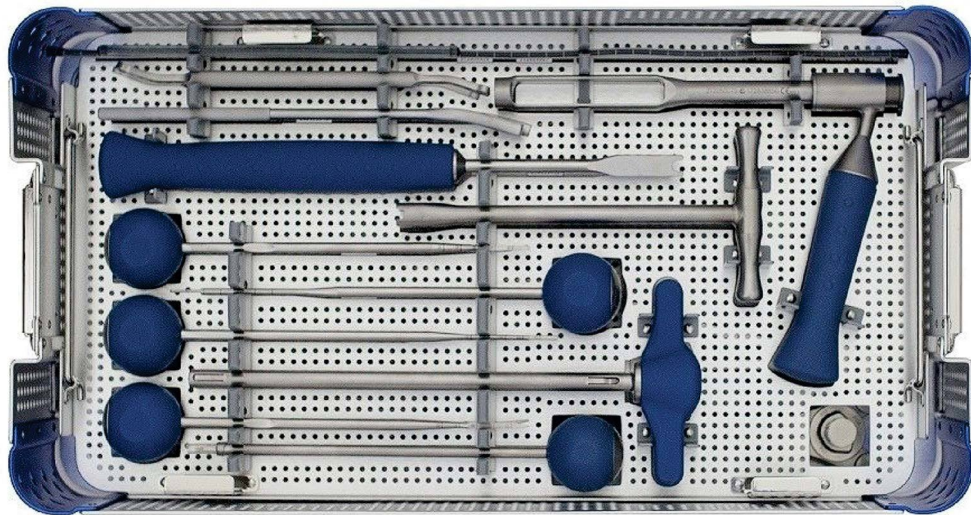

Orthopedic Implant Instrument Set (GBAI-1074)

Sr. #	Code	Instrument Description	Specification	Type	Steel Type	Finish	QTY
01	1074-01	Bone Drill Handle	3-Jaw Chuck	Straight	AISI 410	Satin	1
02	1074-02	Drill Bit Set	Ø 2.0 – 4.5 mm	Straight	AISI 420	Mirror	1 set
03	1074-03	Depth Gauge	up to 75 mm	Straight	AISI 410	Satin	1
04	1074-04	Bone Tap	Ø 3.5 mm / 4.5 mm	Straight	AISI 420	Satin	2
05	1074-05	Screwdriver Handle, AO coupling	Standard	Straight	AISI 410	Satin	1
06	1074-06	Screwdriver Shaft, hex	2.5 mm	Straight	AISI 410	Satin	1
07	1074-07	Screwdriver Shaft, hex	3.5 mm	Straight	AISI 410	Satin	1
08	1074-08	Plate Bending Press	small / medium	Straight	AISI 410	Satin	1
09	1074-09	Bone Holding Forceps	200 mm	Curved	AISI 410	Satin	2
10	1074-10	Reduction Forceps with Pointed Tips	180 mm	Curved	AISI 410	Satin	2
11	1074-11	Screw Holding Forceps	160 mm	Straight	AISI 410	Satin	1
12	1074-12	Tap Wrench	universal	Straight	AISI 410	Satin	1
TOTAL QUANTITY							14



EMERGENCY TRAUMA INSTRUMENT SET - (GBAI-1076)

Sr. #	Code	Instrument Description	Specification	Type	Steel Type	Finish	QTY
01	1076-01	Bandage Scissors, Lister	18 cm	Straight	AISI 420	Mirror	1
02	1076-02	Artery Forceps, Kelly	14 cm	Straight	AISI 420	Mirror	4
03	1076-03	Artery Forceps, Kelly	14 cm	Curved	AISI 420	Mirror	4
04	1076-04	Dissecting Forceps	14 cm	Straight	AISI 410	Satin	2
05	1076-05	Needle Holder, Mayo-Hegar	18 cm	Straight	AISI 410	Satin	1
06	1076-06	Scissors, Operating	14 cm	Curved	AISI 410	Satin	1
07	1076-07	Scalpel Handle	No. 4	Straight	AISI 420	Mirror	1
08	1076-08	Scalpel Handle	#10	Straight	AISI 410	Satin	1
09	1076-09	Dressing Forceps	14 cm	Straight	AISI 410	Satin	1
10	1076-10	Splinter Forceps	12 cm	Straight	AISI 410	Satin	1
11	1076-11	Splinter Forceps	25 cm	Straight	AISI 410	Mirror	1
12	1076-12	Towel Clamp	9 cm	Curved	AISI 410	Satin	2
						TOTAL QUANTITY	20

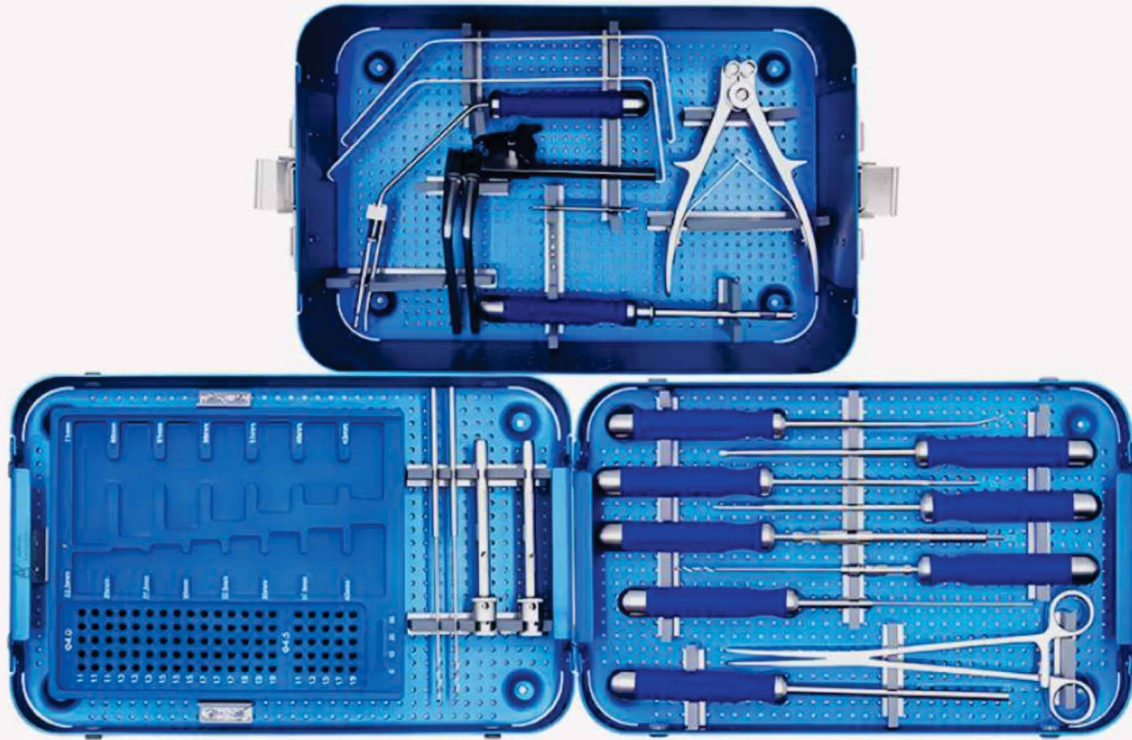

Orthopedic Fixation Instrument Set (GBAI-1002)

Sr. #	Code	Instrument Description	Specification	Type	Steel Type	Finish	QTY
01	ACDF-1001	Adjustable tap	4.0*12-18mm	--	AISI 420 / 410	Satin / Mirror Polish	1
02	ACDF-1002	Adjustable tap	4.5*12-18mm	-	AISI 420 / 410	Satin / Mirror Polish	1
03	ACDF-1003	Adjustable drill bit > 2.4	12-18mm	-	AISI 420 / 440A	Mirror Polish	1
04	ACDF-1004	Adjustable drill bit adjuster	-----	--	AISI 420 / 440A	Satin Finish	1
05	ACDF-1005	Nail	12 mm	—	AISI 410	Mirror Polish	2
06	ACDF-1006	Distraction bolt screwdriver	SW2.5	—	AISI 410	Satin Finish	1
07	ACDF-1007	Cervical retractor(double direction)	Universal	—	AISI 410 / 420	Satin / Sand-Blasted	2
08	ACDF-1008	Puncher	-----	-	AISI 410	Mirror Polish	1
09	ACDF-1009	Screwdriver with sleeve	-----	-	AISI 410	Satin Finish	2
10	ACDF-1010	Guider	01.2x1.5	—	AISI 410 / 420	Satin Finish	1
11	ACDF-1011	Plate holding forcep	-----	—	AISI 420 / 420J2	Mirror Polish	1
12	ACDF-1012	Plate bending forceps	-----	—	AISI 420 / 420J2	Mirror Polish	1
13	ACDF-1013	Plate guide needle	15 mm	—	AISI 410 / 420	Satin Finish	1
14	ACDF-1014	Plate and screw box	18 mm	—	AISI 304	Mirror Polish	1
15	ACDF-1015	Cervical retractor	SW2.0	—	AISI 410 / 420	Satin Finish	1
16	ACDF-1016	16 Cervical retractor 18 mm	2.0x10	—	AISI 410 / 420	Mirror Polish	1
17	ACDF-1017	17 Butterfly hex screwdriver SW2.0	-----	—	AISI 410 / 420	Satin Finish	1
18	ACDF-1018	18 Guide needle	-----	—	AISI 410 / 420	Satin Finish	2
19	ACDF-1019	19 Depth gauge	-----	—	AISI 410 / 420	Mirror Polish	1
20	ACDF-1020	20 Handle AO coupling	-----	----	AISI 410 + Stainless Coupling (AISI 304)	Mirror Polish	1
						TOTAL QUANTITY	24



Neurosurgery Set-(GBAI-1039)

Sr. #	Code	Instrument Description	Specification	Type	Steel Type	Finish	QTY
01	GBAI1039-01	Ferguson Frazier Suction Tube	9 Fr	Curved	AISI 410	Satin	1
02	GBAI1039-02	Scoville Spatula (Malleable Ends 5/8" & 3/4")	20 cm (8")	Malleable	AISI 420	Mirror	1
03	GBAI1039-03	Scoville Spatula (Malleable Ends 5/8" & 3/8")	18 cm (7"), 4 mm Bite	Curved	AISI 420	Mirror	1
04	GBAI1039-04	Stille Luer Rongeur	23 cm (9")	Curved / Angled	AISI 420	Satin	1
05	GBAI1039-05	Love Nerve Retractor	22 cm (8 1/2"), 7 mm Blade	Straight	AISI 420	Satin	1
06	GBAI1039-06	Cushing Perforator Drill	1.2 cm (1/2") Head	Straight	AISI 410	Satin	1
07	GBAI1039-07	Hudson Brace (Large)	-----	Rotary Type	AISI 420	Satin	1
08	GBAI1039-08	Hudson Cerebellar Extension (for Brace)	50 cm (4")	Attachment	AISI 420	Mirror	1
09	GBAI1039-09	Gigli Saw (Twisted Wire)	9 cm (3 1/2")	Flexible Wire Type	AISI 410	Mirror	1
10	GBAI1039-10	Modified Gigli Bone Saw Wire (Turnable)	14 cm (5 1/2")	Rotating Type	AISI 410	Satin	2
11	GBAI1039-11	Joseph Double Prong Single Hook	18.5 cm (7 1/2"), 11 mm Bite	Straight	AISI 410	Satin	1
12	GBAI1039-12	Kerrison Cervical Rongeur	18 cm (7"), 40° Forward, 3 mm Bite	Angled	AISI 420	Satin	1
13	GBAI1034-13	Ferguson Frazier Suction Tube	7 Fr	Curved	AISI 420	Satin	1
14	GBAI1039-14	Cushing Rongeur	13 cm (5"), 2x10 mm Cup	Up-Biting	AISI 420	Mirror	1
15	GBAI1039-15	Cushing Spatula Spoon (1/2" & 3/4" Ends)	20 cm (8")	Double-Ended	AISI 420	Mirror	1
16	GBAI1039-16	Frazier Skin Hook	20 cm (6 1/4")	Blunt	AISI 210	Satin	1
17	GBAI1039-17	Frazier Dura Separator	16.5 cm (6 1/2"), 1/2" Blade	Angled	AISI 410	Satin	1
18	GBAI1039-18	Adson Dura Hook (Blunt, Right Angle)	20 cm (8"), 5 mm Blade	Right Angle	AISI 410	Satin	2
19	GBAI1039-19	Love Nerve Retractor	22 cm (8 1/2"), 7 mm Blade	45° Angled	AISI 420	Satin	1
20	GBAI1039-20	Love Nerve Retractor	22 cm (8 1/2"), 7 mm Blade	90° Angled	AISI 420	Satin	1
21	GBAI1039-21	Ribbon Retractor (Malleable)	23 cm (9"), Tip 1.5x6 mm	Curved	AISI 410	Mirror	1
22	GBAI1039-22	Allis Tissue Forceps (4x5 Teeth) Grooved Director (Probe End)	16.5 cm (6 1/2")	Curved Blunt	AISI 420	Mirror	1
23	GBAI1039-23	Allis Tissue Forceps (4x5 Teeth)	15 cm (6")	Straight	AISI 420	Satin	2
24	GBAI1039-24	Knife Handle No. 3	13 cm	Straight	AISI 420	Satin	1

Neurosurgery Set-(GBAI-1039)

Sr. #	Code	Instrument Description	Specification	Type	Steel Type	Finish	QTY
25	GBAI1039-25	Langenbeck Periosteal Elevator (7 mm Tip)	18 cm (7")	Blunt	AISI 420	Satin	1
26	GBAI1039-26	Langenbeck Periosteal Elevator (7 mm Tip)	18 cm (7")	Blunt	AISI 410	Mirror	1
27	GBAI1039-27	Michel Wound Clips (11 mm)	-----	Pack (100/Envelope)	AISI 410	Mirror	1
28	GBAI1039-28	Adson Hemostatic Forceps	18 cm (7¼")	Curved	AISI 304	Polished	2
29	GBAI1039-29	Metzenbaum Scissors (Standard, TC)	18 cm (7")	Curved	AISI 410	Satin	1
30	GBAI1039-30	Mayo Scissors (TC, Curved)	14 cm (5½")	Angled	AISI 420	Satin	1
31	GBAI1039-31	Potts-Smith Scissors (Angled 25°)	19 cm (5½")	Straight	AISI 420	Satin	1
32	GBAI1039-32	Semken Tissue Forceps (1×2 Teeth)	15 cm (6")	Straight	AISI 420	Mirror	1
33	GBAI1039-33	Semken Tissue Forceps (1×2 Teeth)	12 cm (4¾")	Straight	AISI 420	Mirror	1
34	GBAI1039-34	Adson Tissue Forceps (1×2 Teeth)	12 cm (4¾")	Straight	AISI 420	Mirror	1
35	GBAI1039-35	Adson Tissue Forceps (1×2 Teeth)	12.5 cm (5")	Curved	AISI 420	Mirror	6
36	GBAI1039-36	Allis Tissue Forceps 4×5 Teeth	12.5 cm (5")	Straight	AISI 420	Mirror	6
37	GBAI1039-37	Halsted Mosquito Micro Forceps (Delicate)	12 cm (4¾")	Straight	AISI 420	Mirror	2
38	GBAI1039-38	Rochester Ochsner Forceps	13 cm (5¼")	Straight	AISI 420	Mirror	1
39	GBAI1039-39	Rochester Ochsner Forceps	21.5 cm (8½")	Straight	AISI 420	Mirror	12
40	GBAI1039-40	Adson Hemostatic Forceps	18 cm (7¼")	Lateral Curved	AISI 420	Mirror	2
41	GBAI1039-41	Backhaus Towel Clamp	9 cm (3½")	Straight	AISI 420	Satin	8
42	GBAI1039-42	Backhaus Towel Clamp	13 cm (5¼")	Straight	AISI 420	Satin	8
43	GBAI1039-43	Mayo Scissors (TC, Straight)	14 cm (5½")	Straight	AISI 410	Satin	1
44	GBAI10.39-44	Foerster Sponge Forceps (Serrated Jaws)	24 cm (9½")	Straight	AISI 410	Mirror	1
45	GBAI1039-45	Crile-Wood Needle Holder (TC Jaws)	18 cm (7")	Straight	AISI 410	Mirror	1
46	GBAI1039-46	Crile-Wood Needle Holder (TC Jaws)	15 cm (6")	Straight	AISI 420	Mirror	1
47	GBAI1039-47	Jansen Mastoid Retractor (3×3 Teeth, Blunt)	8 cm (3¼")	Self-Retaining	AISI 420	Mirror	1
48	GBAI1039-48	Wire Cutting Scissors (Angled, Serrated)	12 cm (4¾")	Angled	AISI 420	Mirror	1
49	GBAI1039-49	Jansen-Wagner Retractor (5×5 Sharp Teeth)	12.5 cm (5")	Self-Adjusting	AISI 420	Mirror	1
50	GBAI1039-50	Jansen-Wagner Retractor (3×3 Sharp Teeth)	8 cm (3¼")	Self-Retaining	AISI 420	Mirror	1
51	GBAI1039-51	Senn-Miller Retractor (3 Prong Sharp)	16 cm (6¼")	Double-Ended	AISI 420	Mirror	2
52	GBAI1039-52	Murphy Rake Retractor (4 Sharp Prongs)	19 cm (7½")	Rake Type	AISI 420	Mirror	2
53	GBAI1039-53	Adson Retractor (4×4 Sharp Teeth)	19 cm (7½")	Straight	AISI 420	Mirror	1
54	GBAI1039-54	Beckman Retractor (Hinged, 4×4 Sharp Teeth)	32 cm (12½"), 19×25 mm Blades	Hinged	AISI 420	Mirror	1
55	GBAI1039-55	Freer Elevator (Double End, 5 mm Blade)	18 cm (7")	Sharp / Blunt	AISI 420	Mirror	1
TOTAL QUANTITY							98

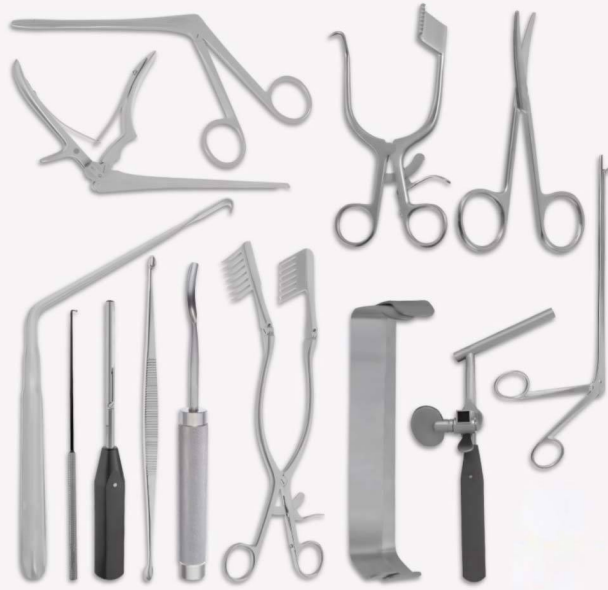

Spinal Surgery Instruments Set-(GBAI-1044)

Sr. #	Code	Instrument Description	Specification	Type	Steel Type	Finish	QTY
01	GBAI1044-01	Markham-Meyering Retractor (Right)	18 cm	Curved / Right-Sided	AISI 420	Satin	1
02	GBAI1044-02	Markham-Meyering Retractor (Left)	18 cm	Curved / Left-Sided	AISI 420	Satin	1
03	GBAI1044-03	Beckman-Eaton Retractor (Sharp Teeth)	32 cm	Hinged / Self-Retaining	AISI 420	Satin	1
04	GBAI1044-04	Lane Retractor Set	23 cm	Double Ended	AISI 420	Mirror	1
05	GBAI1044-05	Cobb Spinal Fusion Gouge	6 mm Tip x 28 cm	Straight	AISI 410	Mirror	1
06	GBAI1044-06	Williger Mallet (Round Head, 14 oz)	24 cm / 30 mm Head	Solid Head	AISI 304 (Head), AISI 410 (Handle)	Matte	1
07	GBAI1044-07	Stille-Horsley Bone Cutter	27 cm	Angled Jaw	AISI 420	Mirror	1
08	GBAI1044-08	Williger Bone Curette	3 mm x 4.2 mm x 13.5 cm	Curved	AISI 420	Mirror	1
09	GBAI1044-09	Scoville Nerve Root Retractor	7 mm Blade x 19 cm	Straight	AISI 420	Satin	1
10	GBAI1044-10	Kerrison Laminectomy Rongeur	40° Upward, 5 mm x 180 mm	Angled	AISI 420	Satin	1
11	GBAI1044-11	Joseph Double Prong Single Hook	40° Upward, 3 mm x 180 mm	Angled	AISI 420	Satin	1
12	GBAI1044-12	Ferguson Frazier Suction Tube	40° Upward, 2 mm x 180 mm	Angled	AISI 420	Satin	1
13	GBAI1044-13	Caspar Drill Guide	-----	Straight	AISI 420	Satin	1
14	GBAI1044-14	Caspar Vertebral Body Distractor	-----	Adjustable	AISI 420	Mirror	1
15	GBAI1044-15	Caspar Twist Drill	1.7 mm Dia x 8 mm Depth x 2.35 mm Shank	Straight	AISI 420	Satin	1
16	GBAI1044-16	Caspar Distraction Screw	16 mm Thread x 70 mm Length	Adjustable	AISI 410	Satin	2
17	GBAI1044-17	Rochester Ochsner Forceps	16.5 cm, 90 mm Spread	Straight	AISI 410	Mirror	1
18	GBAI1044-18	Foerster Sponge Forceps (Serrated Jaws)	-----	Straight	AISI 410	Satin	1
19	GBAI1044-19	Cushing Vein Retractor	16 cm	Curved	AISI 420	Satin	1
20	GBAI1044-20	U.S. Army Retractor (Double Ended)	24.5 cm	Curved	AISI 420	Satin	1
21	GBAI1044-21	Dressing Scissors (TC Insert)	18.5 cm	Straight	AISI 420 (Insert T.C.)	Mirror	1
22	GBAI1044-22	Dressing Scissors (TC Insert)	20 cm	Straight	AISI 420 (Insert T.C.)	Mirror	1
23	GBAI144-23	Dietrich Scissors	16 cm, 45°	Angled	AISI 420	Mirror	1
24	GBAI1044-24	Potts-Smith Scissors (TC)	19 cm, 60°	Angled	AISI 420 (Insert T.C.)	Mirror	1
25	GBAI1044-01	Cushing Upward Rongeur	5 mm x 150°	Upward Angled	AISI 420	Satin	1
26	GBAI1044-02	Metzenbaum Scissors	15 cm	Curved	AISI 420	Satin	1
27	GBAI1044-03	Schlesinger Rongeur	2 mm x 10 mm	Straight	AISI 420	Satin	1
28	GBAI1044-03	Oldberg Rongeur	7 mm x 25 cm	Straight	AISI 420	Satin	1
						TOTAL QUANTITY	29

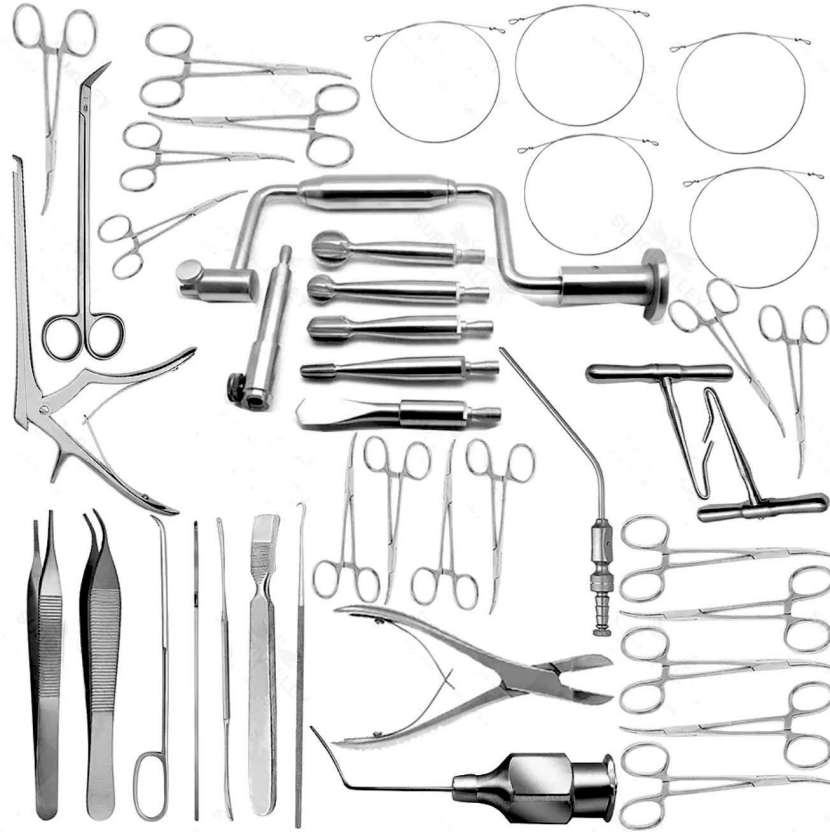

CRANIOTOMY BASIC SURGERY SET - (GBAI-1063)

Sr. #	Code	Instrument Description	Specification	Type	Steel Type	Finish	QTY
01	1063-01	Hudson Brace (Large)	-----	Rotary	AISI 410	Satin	2
02	1063-02	Hudson Perforator with Bits	-----	Perforator	AISI 410	Satin	2
03	1063-03	Gigli Saw with Handles	20" (50 cm) wire	Flexible	AISI 410	Satin	6
04	1063-04	Dandy Nerve Hook	9" tip 1.5×6 mm	Curved	AISI 420	Satin	6
05	1063-05	Adson Dura Hook Right Angle	8" (20 cm), 5 mm	Right Angle	AISI 420	Satin	1
06	1063-06	Cushing Rongeur Up-Biting	5" (13 cm), 2×10 mm	Upward	AISI 420	Satin	1
07	1063-07	Kerrison Rongeur	40° forward, 3 mm × 180 mm	Angled	AISI 410	Satin	2
08	1063-08	Kerrison Rongeur	40° forward, 5 mm × 180 mm	Angled	AISI 420	Satin	1
09	1063-09	Leksell Rongeur (Double Action)	7" (18 cm)	Curved	AISI 420	Satin	1
10	1063-10	Freer Elevator, Double End	7" (18 cm), 5 mm	Sharp/Blunt	AISI 410	Satin	1
11	1063-11	Frazier Suction Tube	7 Fr	Curved	AISI 410	Satin	1
12	1063-12	Frazier Suction Tube	9 Fr	Curved	AISI 420	Satin	1
13	1063-13	Adson Forceps 1×2 Teeth	4¾" (12 cm)	Straight	AISI 420	Satin	1
14	1063-14	Bipolar Forceps (Reusable)	0.5 mm tip	Bayonet	AISI 420	Satin	1
15	1063-15	Metzenbaum Scissors Delicate	7" (18 cm)	Curved	AISI 420	Satin	1
16	1063-16	Mayo Scissors	6¾" (17 cm)	Straight	AISI 420	Satin	2
17	1063-17	Weillaner Retractor 3×4 Sharp	6¾" (16.5 cm)	Self-Retaining	AISI 410	Satin	1
18	1063-18	Dura Scissors (Potts-Smith)	7½" (19 cm) 45°	Angled	AISI 420	Satin	1
19	1063-19	Backhaus Towel Clamp	5¼" (13 cm)	Curved	AISI 410	Satin	6
20	1063-20	Mayo-Hegar Needle Holder	6" (15 cm)	Straight	AISI 420	Satin	2
TOTAL QUANTITY							26



LEYLA RETRACTOR SET - (GBAI-1069)

Sr. #	Code	Instrument Description	Specification	Type	Steel Type	Finish	QTY
01	1069-01	Table side-rail clamp (universal)	Fits 25 × 10 mm side-rail	Clamp Type	AISI 410	Satin	1
02	1069-02	Vertical post	25 cm	Straight Post	AISI 410	Satin	1
03	1069-03	Vertical post	Ø 25 mm head	Ball-Joint Turret	AISI 410	Satin	1
04	1069-04	Flexible arm (heavy)	45 cm	Flexible Arm (heavy)	AISI 410	Satin	1
05	1069-05	Flexible arm (standard)	35 cm	Flexible Arm (standard)	AISI 410	Satin	1
06	1069-06	Flexible arm (micro)	25 cm	Flexible Arm (micro)	AISI 410	Satin	1
07	1069-07	Quick-coupling joint	Standard 20 mm socket	Quick-Coupler	AISI 410	Satin	2
08	1069-08	Swivel joint coupler	30 mm head	Swivel Coupler	AISI 410	Satin	2
09	1069-09	Blade holder, straight micro	12 cm	Straight Holder	AISI 420	Mirror	1
10	1069-10	Blade holder, angled micro	12 cm	Angled Holder	AISI 420	Mirror	1
11	1069-11	Blade holder, bayonet	14 cm	Bayonet Holder	AISI 420	Satin	1
12	1069-12	Brain spatula, silicone-coated	20 cm	Silicone Spatula	AISI 420	Satin	1
13	1069-13	Brain spatula, silicone-coated	8 mm × 120 mm	Silicone Spatula	AISI 420	Satin	1
14	1069-14	Brain spatula, silicone-coated	10 mm × 150 mm	Silicone Spatula	AISI 420	Satin	1
15	1069-15	Brain spatula, silicone-coated	12 mm × 180 mm	Silicone Spatula	AISI 420	Satin	1
16	1069-16	Brain spatula, silicone-coated	15 mm × 180 mm	Silicone Spatula	AISI 420	Satin	1
17	1069-17	Micro paddle retractor	20 mm × 200 mm	Paddle Blade	AISI 420	Satin	1
18	1069-18	Micro paddle retractor	10 × 15 mm	Paddle Blade	AISI 420	Satin	1
19	1069-19	Micro paddle retractor	15 × 20 mm	Paddle Blade	AISI 420	Satin	1
20	1069-20	Malleable wire retractor	Ø 2.0 mm × 30 cm	Malleable	AISI 420	Satin	1
21	1069-21	Vessel / nerve hook (small)	12 cm	Hook Small	AISI 420	Mirror	1
22	1069-22	Vessel / nerve hook (medium)	14 cm	Hook medium	AISI 420	Mirror	1
23	1069-23	Light / smoke clip bracket	8 mm port	Bracket	AISI 410	Satin	1
24	1069-24	Torque wrench for ball joints	13 cm	Tool	AISI 410	Satin	1
25	1069-25	Spare ball-joint set	Set of 6	Spare Parts	AISI 410	Satin	1
26	1069-26	Knurled thumb-screws set	Set of 6	Spare Parts	AISI 410	Satin	1
27	1069-27	Drape clips for flexible arms	Set of 4	Clip	AISI 410	Satin	4
28	1069-28	Instrument storage tray with silicone mat	480 × 280 × 40 mm	Tray Type	AISI 410	Satin	1
TOTAL QUANTITY							33



Basic ENT Instrument set(GBAI-1009)

Sr. #	Code	Instrument Description	Specification	Type	Steel Type	Finish	QTY
01	GBAI1009-01	Allis Forceps, 4x5 Teeth	7 FR	-	AISI 304 / 316L	Mirror Polish	1
02	GBAI1009-02	Baron Suction Tube	17 CM	-	AISI 420 / 440A	Mirror Polish	1
03	GBAI1009-03	Baron Suction Tube	17 CM	-	AISI 420 / 440A	Mirror Polish	1
04	GBAI1009-04	Billeau Ear Loop Large	17 CM	-	AISI 420 / 440A	Mirror Polish	1
05	GBAI1009-05	Billeau Ear Loop Medium	SIZE 0	-	AISI 420 / 440A	Satin Finish	1
06	GBAI1009-06	Billeau Ear Loop Small	SIZE 0	-	AISI 420 / 440A	Satin Finish	1
07	GBAI1009-07	Buck Ear Curette Straight, Sharp	SIZE 1	-	AISI 420 / 440A	Satin Finish	1
08	GBAI1009-08	Buck Ear Curette Straight, Straight	SIZE 1	-	AISI 420 / 440A	Satin Finish	1
09	GBAI1009-09	Buck Ear Curette Straight, Sharp	SIZE 2	-	AISI 420 / 440A	Satin Finish	1
10	GBAI1009-10	Buck Ear Curette Straight, Blunt	SIZE 2	-	AISI 420 / 440A	Satin Finish	1
11	GBAI1009-11	Buck Ear Curette Straight, Sharp	17 CM	-	AISI 420 / 440A	Satin Finish	1
12	GBAI1009-12	Buck Ear Curette Straight, Blunt	17 CM	-	AISI 420 / 440A	Satin Finish	1
13	GBAI1009-13	Day Ear Hook Large	25 CM	-	AISI 410 / 420	Mirror Polish	1
14	GBAI1009-14	Day Ear Hook Small	16 CM	-	AISI 410 / 420	Mirror Polish	1
15	GBAI1009-15	Hartmann Alligator Ear Forceps	12 CM	-	AISI 410 / 420	Mirror Polish	1
16	GBAI1009-16	Hartmann Forceps, Round Cup	15 CM	-	AISI 410 / 420	Mirror Polish	1
17	GBAI1009-17	Iris Scissors, Sharp	12 CM	Straight	AISI 420 / 420J2	Mirror Polish	1
18	GBAI1009-18	Iris Scissors, Sharp	11 CM	Curved	AISI 420 / 420J2	Mirror Polish	1
19	GBAI1009-19	Lucae Bayonet Forceps	11 CM	-	AISI 420 / 440A	Satin Finish	1
20	GBAI1009-20	Micro Alligator Ear Forceps Cup Type	1 X 0.9 MM	-	AISI 420A	Satin Finish	1
21	GBAI1009-21	Knife Rochester-Pean Forcep	0.6 MM	-	AISI 420 / 440A	Satin Finish	1
22	GBAI1009-22	Micro Alligator Ear Forceps Serr, Straight	0.8 MM	-	AISI 420 / 440A	Satin Finish	1
23	GBAI1009-23	Noyes Alligator Forceps	9 CM	-	AISI 420 / 440A	Satin Finish	1
24	GBAI1009-24	Shapleigh Ear Curette Medium	13 CM	-	AISI 420 / 440A	Mirror Polish	1
25	GBAI1009-25	Shapleigh Ear Curette Medium	13 CM	-	AISI 420 / 440A	Mirror Polish	1
26	GBAI1009-26	Strabismus Scissors	11 CM	Straight	AISI 420 / 440A	Mirror Polish	1
27	GBAI1009-27	Strabismus Scissors	11 CM	Curved	AISI 420 / 440A	Mirror Polish	1
28	GBAI1009-28	Vienna Nasal Speculum	LARGE	-	AISI 420 / 440A	Mirror Polish	1
29	GBAI1009-29	Vienna Nasal Speculum	MEDIUM	-	AISI 304 / 316L	Mirror Polish	1
30	GBAI1009-30	Vienna Nasal Speculum	SMALL	-	AISI 304 / 316L	Mirror Polish	1
31	GBAI1009-31	Wilde Ear Dressing Forceps	12 CM	-	AISI 304 / 316L	Mirror Polish	1
32	GBAI1009-32	Wilde Ear Dressing Forceps	12 CM	-	AISI 410 / 420	Mirror Polish	1
						TOTAL QUANTITY	33



ENT SINUS TONSIL SET - (GBAI 1056)

Sr. #	Code	Instrument Description	Specification	Type	Steel Type	Finish	QTY
01	1056-01	Boyle-Davis Mouth Gag with Blade	-----	Self-Retaining	AISI 410	Satin	1
02	1056-02	Jennings Mouth Gag	-----	Self-Retaining	AISI 410	Satin	1
03	1056-03	Hurd Dissector / Pillar Retractor	-----	Double-Ended	AISI 420	Mirror	1
04	1056-04	Frazier Suction Tube	8 Fr	Curved	AISI 410	Satin	1
05	1056-05	Frazier Suction Tube	10 Fr	Curved	AISI 410	Satin	6
06	1056-06	Schnidt Tonsil Hemostat	19 cm	Curved	AISI 420	Satin	1
07	1056-07	LaForce Adenoid Curette	-----	Ring Type	AISI 420	Mirror	1
08	1056-08	Tonsil Snare (Eve)	-----	Wire Type	AISI 410	Mirror	1
09	1056-09	Dennis Browne Tonsil Seizing Forceps	-----	Curved	AISI 410	Mirror	9
10	1056-10	Metzenbaum Scissors	18 cm	Curved	AISI 420	Satin	2
11	1056-11	Mayo Scissors	17 cm	Straight	AISI 420	Satin	1
12	1056-12	Adson Forceps 1x2	12 cm	Straight	AISI 420	Mirror	1
13	1056-13	Foerster Sponge Forceps	24 cm	Straight	AISI 410	Satin	2
14	1056-14	Backhaus Towel Clamp	13 cm	Curved	AISI 410	Satin	6
TOTAL QUANTITY							26



Tracheotomy Set-(GBAI-1051)

Sr. #	Code	Instrument Description	Specification	Type	Steel Type	Finish	QTY
01	GBAI1051-01	Surgical Knife Handle No. 3	14 cm (5 1/2")	Straight	AISI 420	Satin	1
02	GBAI1051-02	Lucan Trachea Retractor	15 cm (6")	Curved / Retractor	AISI 410	Satin	1
03	GBAI1051-03	Crile Hemostatic Forceps	14 cm (5 1/2")	Curved	AISI 410	Satin	4
04	GBAI1051-04	Trachea Retractor, 1 Prong, Sharp	16.5 cm (6 1/2")	Sharp	AISI 410	Satin	1
05	GBAI1051-05	Crile-Wood Needle Holder	13 cm (5")	Straight	AISI 420 + TC	Mirror	1
06	GBAI1051-06	Weitlaner Retractor	17 cm (6 3/4")	Sharp / Self-Retaining	AISI 410	Satin	1
07	GBAI1051-07	Skillman Mosquito Forceps	13 cm (5")	Straight	AISI 410	Satin	3
08	GBAI1051-08	Skillman Mosquito Forceps	13 cm (5")	Curved	AISI 410	Satin	3
09	GBAI1051-09	Mayo-Pean Forceps	14 cm (5 1/2")	Curved	AISI 410	Satin	2
10	GBAI1051-10	Allis Tissue Forceps, 5x6 Teeth	15 cm (6")	Straight	AISI 410	Satin	2
11	GBAI1051-11	Backhaus Towel ClampHook	7.5 cm (3")	Curved	AISI 410	Mirror	4
12	GBAI1051-12	Ballenger Sponge Forceps	18 cm (7")	Curved	AISI 420	Mirror	1
13	GBAI1051-13	Jackson-Trousseau Tracheal Dilator	15 cm (6")	Curved	AISI 410	Satin	1
14	GBAI1051-14	Adson Dressing Forceps, Serrated Tip	12.5 cm (5")	Straight	AISI 420	Satin	1
15	GBAI1051-15	Adson Tissue Forceps, 1x2 Teeth	12.5 cm (5")	Curved	AISI 410	Mirror	1
16	GBAI1051-16	Periosteal Elevator (Straight/Curved Tip)	12 mm Wide	Straight	AISI 420	Satin	1
17	GBAI1051-17	Metzenbaum Scissors	12 cm (4 3/4")	Straight	AISI 420	Satin	1
18	GBAI1051-18	Mayo Scissors	14 cm (5 1/2")	Curved	AISI 420	Mirror	1
19	GBAI1051-19	Cushing Vein Retractor	17 cm (6 3/4")	Curved	AISI 410	Mirror	2
20	GBAI1051-20	Yankauer Suction Tube (Stainless Steel)	20 Fr	Curved	AISI 304 (for Suction Tube)	Mirror	1
21	GBAI1051-21	Sterilization Box	Standard	Box Type	AISI 304 (for Sterilization Box)	Satin	1
TOTAL QUANTITY							34



Thyroidectomy Instruments Set-(GBAI-1049)

Sr. #	Code	Instrument Description	Specification	Type	Steel Type	Finish	QTY
01	GBAI1049-01	Allis Tissue Forceps 4x5 Teeth	15 cm (6")	Straight	AISI 410	Satin	2
02	GBAI1049-02	Crile-Wood Needle Holder T.C. Smooth Jaws	15 cm (6")	Straight	AISI 410	Mirror	1
03	GBAI1049-03	Cushing Vein & Nerve Retractor	23 cm (9")	Curved	AISI 410	Satin	1
04	GBAI1049-04	Lahey Tenaculum Forceps	15 cm (6")	Straight	AISI 410	Satin	6
05	GBAI1049-05	Green Thyroid Retractor	21.5 cm (8 1/2")	Straight	AISI 410	Satin	1
06	GBAI1049-06	Lovelace Hemostatic Forceps 1x2 Teeth	16 cm (6 1/4")	Curved	AISI 410	Satin	2
07	GBAI1049-07	Metzenbaum Scissors Delicate T.C	18 cm (7")	Curved	AISI 420 + TC	Mirror	1
08	GBAI1049-08	Metzenbaum Scissors Standard T.C.	18 cm (7")	Curved	AISI 420 + TC	Mirror	1
09	GBAI1049-09	Joseph Hook Sharp Single Prong	15 cm (6")	Sharp	AISI 410	Mirror	2
10	GBAI1049-10	Joseph Double Prong Skin Hook	15 cm (6")	Sharp	AISI 410	Satin	2
11	GBAI1049-11	Ferguson Frazier Suction Tube	9 Fr	Blunt	AISI 304 (for Suction Tube)	Mirror Polish	1
12	GBAI1049-12	Volkman Retractor 4 Prongs Blunt	16 cm (6 1/4")	Blunt	AISI 410	Satin	2
13	GBAI1049-13	Burford Finochietto Rib Spreader (Aluminum)	10 cm (4")	Sharp	AISI 410	Satin	1
14	GBAI1049-14	Bailey Rib Contractor Standard	8 cm (3 1/4")	Straight	AISI 410	Satin	1
15	GBAI1049-15	Allison Lung Retractor	16 cm (6 1/4")	Straight	AISI 420	Satin	2
16	GBAI1049-16	Iris Scissors Sharp Tips	11.5 cm (4 1/2")	Curved	AISI 420	Mirror	1
17	GBAI1049-17	Webster Needle Holder T.C. Smooth Jaws	12 cm (4.75")	Straight	AISI 420 + TC	Mirror	1
18	GBAI1049-18	Alexander Farabeuf Periosteotome	20 cm (8")	Straight	AISI 420	Satin	8
19	GBAI1049-19	Foerster Sponge Forceps Serrated Jaws	21.5 cm (8 1/2")	Curved	AISI 420	Satin	1
20	GBAI1049-20	Gemini Mixer Forceps Full Curved	14 cm (5 1/2")	Straight	AISI 410	Satin	2
21	GBAI1049-21	Kelly Hemostatic Forceps	14 cm (5 1/2")	Curved	AISI 410	Satin	1
22	GBAI1049-22	Crile Rankin Hemostatic Forceps	16 cm (6 1/4")	Curved	AISI 410	Satin	1
23	GBAI1049-23	Halstead Mosquito Forceps	12 cm (4 3/4")	Curved	AISI 410	Satin	2
24	GBAI1049-24	Halstead Mosquito Forceps	12 cm (4 3/4")	Straight	AISI 410	Satin	2
25	GBAI1049-25	Adson-Brown Tissue Forceps 7x7 Teeth	12 cm (4 3/4")	Straight	AISI 410	Satin	1
26	GBAI1049-26	Adson Tissue Forceps 1x2 Teeth	12 cm (4 3/4")	Straight	AISI 420	Mirror	1
27	GBAI1049-27	Adson Dressing Forceps Serrated	12 cm (4 3/4")	Straight	AISI 410	Satin	1
28	GBAI1049-28	Ragnell Dissecting Scissors	13 cm (5")	Straight	AISI 420	Mirror	1
29	GBAI1049-29	Iris Scissors Sharp Tips	11.5 cm (4 1/2")	Curved	AISI 420	Mirror	1
30	GBAI1049-30	Metzenbaum Dissecting Scissors Delicate - Lahey	13 cm (5")	Curved	AISI 420	Mirror	1
						TOTAL QUANTITY	51



Intubation Set(GBAI-1030)

Sr. #	Code	Instrument Description	Specification	Type	Steel Type	Finish	QTY
01	GBAI1030-01	Penlite Laryngoscope Handle (Chrome-Plated)	13 cm	Straight	AISI 410	Chrome-Plated	1
02	GBAI1030-02	Oropharyngeal Color-Coded Guedel Airways	4-10 cm	Curved	Plastic (Medical Grade, Color-Coded)	Polished	8
03	GBAI1030-03	Medium Laryngoscope Handle (Chrome-Plated)	15 cm	Straight	AISI 410 / 440	Chrome-Plated	1
04	GBAI1030-04	Macintosh Laryngoscope Blades (Sizes 1-4)	9-15 cm	Curved	AISI 410	Polished	4
05	GBAI1030-05	Macintosh Laryngoscope Blades (Sizes 0-4)	7-15 cm	Straight	AISI 410	Polished	5
06	GBAI1030-06	Extra Laryngoscope Lamps (2 Small, 2 Large)	-----	-----	AISI 410	Polished	4
07	GBAI1030-07	Adult Magill Forceps	20 cm	Curved	AISI 304	Satin	1
08	GBAI1030-08	Pediatric Magill Forceps	14 cm	Curved	AISI 410	Satin	1
09	GBAI1030-09	"AA" Batteries	Standard 1.5 V	-----	AISI 410	Satin	2
10	GBAI1030-10	"C" Batteries	Standard 1.5 V	-----	-----	-----	2
11	GBAI1030-11	Endotracheal Tubes (Uncuffed, 2.5-4 mm)	2.5-4 mm ID	Straight	-----	-----	2
12	GBAI1030-12	Sterile Lubricating Jelly Packets	-----	-----	Medical PVC	Transparent	4
13	GBAI1030-13	Endotracheal Tubes (Cuffed, 5-10 mm)	5-10 mm ID	Straight	-----	-----	8
14	GBAI1030-14	Syringe (10 mL)	10 ml	Straight	Medical PVC	Transparent	1
15	GBAI1030-15	Nasopharyngeal Airways (Sizes 20, 24, 28, 32 Fr)	20-32 Fr	Curved	Polypropylene	Transparent	4
16	GBAI1030-16	Adult Stylette	35 cm	Straight (Flexible Shaft)	Medical Rubber (Soft-Tip PVC)	Smooth	1
17	GBAI1030-17	Endotracheal Tube Introducer (Bougie, Coudé Tip)	60 cm	Curved Tip	Nylon-Coated Stainless Steel	Mirror	1
18	GBAI1030-18	Nylon Airway Management Case	-----	-----	Nylon	Mat Nylon	1
						TOTAL QUANTITY	30



Blepharoplasty Instrument Set (GBAI-1013)

Sr. #	Code	Instrument Description	Specification	Type	Steel Type	Finish	QTY
01	GBAI1013-01	Adson Tissue Forceps	12 cm	Straight	AISI 420A / 420B	Mirror Polish	1
02	GBAI1013-02	Backhaus Towel Clamp	9 cm	Curved (tips curved clamp)	AISI 410 / 420	Mirror Polish	1
03	GBAI1013-03	Curved Iris Scissors	11.5 cm	Curved	AISI 410 / 440A	Mirror Polish	1
04	GBAI1013-04	Double Fixation Hook	8 cm	Straight	AISI 420A / 420B	Satin Finish (TC edges)	1
05	GBAI1013-05	Barraquer Needle Holder Curved with Lock	14 cm	Straight	AISI 410 + Tungsten Carbide (TC) Blades	Satin Finish (TC edges)	1
06	GBAI1013-06	Berky Ptois Forceps	9 cm	Straight	AISI 410 / 420	Mirror Polish	4
07	GBAI1013-07	Halsted Mosquito Forceps	7cm	Straight	AISI 410 / 420	Satin Finish	1
08	GBAI1013-08	Halsted Mosquito Forceps	9 cm	Straight	AISI 420 / 420J2	Satin Finish	1
09	GBAI1013-09	Halsted Straight Mosquito Forceps	12.5 cm	Straight	AISI 420 / 420J2	Mirror Polish	1
10	GBAI1013-10	Berke Ptois Forceps	9cm	Straight	AISI 420A	Mirror Polish	1
11	GBAI1013-11	Bishop Harmon Dressing Forceps	8 cm	Straight	AISI 410 + TC Jaws	Satin Finish (TC jaws)	1
12	GBAI1013-12	Halsted Curved Mosquito Forceps	12.5 cm	Curved	AISI 410 + TC Jaws	Satin Finish (TC jaws)	1
13	GBAI1013-13	Bishop Harmon Straight Tissue Forceps	8.5 cm	Straight	AISI 410 / 420	Mirror Polish	1
14	GBAI1013-14	Brown Adson Tissue Forceps	12 cm	Straight	AISI 410 + TC Jaws	Satin Finish (TC jaws)	1
15	GBAI1013-15	Joseph Double Hook	7 cm	Straight	AISI 410 + TC Jaws	Satin Finish (TC jaws)	1
16	GBAI1013-16	Joseph Double Skin Hook Larger	9.5 cm	Straight	AISI 420 / 440A	Mirror Polish	1
17	GBAI1013-17	Castroviejo Caliper	11 cm	Straight	AISI 420 / 440A	Mirror Polish	1
18	GBAI1013-18	Castroviejo Fixation Forceps	14 cm	Straight	AISI 420 / 440A	Mirror Polish	1
19	GBAI1013-19	Allis Tissue ForcePS 4x5 Teeth	8.5 cm	Straight	AISI 420 / 440A	Mirror Polish	1
20	GBAI1013-20	Gillies Skin Hooks 4mm	9 cm	Straight	AISI 420A	Satin Finish	1
21	GBAI1013-21	Knife Rochester-Pean Forcep	12 cm	CURVED	AISI 420 / 420J2	Mirror Polish	1
22	GBAI1013-22	Putterman Eyelid Creaser	12 cm		AISI 410 / 420	Satin Finish	1
23	GBAI1013-23	Putterman Gladstone Transmarginal Clamp	8 cm	Straight	AISI 410 / 420	Mirror Polish	1
24	GBAI1013-24	Steven Curved Tenotomy Scissors	11.5 cm	Curved	AISI 304	Mirror Polish	1

Blepharoplasty Instrument Set(GBAI-1013)

Sr. #	Code	Instrument Description	Specification	Type	Steel Type	Finish	QTY
25	GBAI1013-25	Putterman Muller Muscle's Conjunctival	8 cm	Straight	AISI 420 / 440A	Mirror Polish	1
26	GBAI1013-26	Resection Ptosis Clamp	11.5 cm	Straight	AISI 420 / 440A	Mirror Polish	1
27	GBAI1013-27	Straight IRIS Scissor	15 cm	Straight	AISI 304 / 316L	Mirror Polish	1
28	GBAI1013-28	Stainless Steel Flexible Ruler	9 cm	Straight	AISI 420 / 440A	Mirror Polish	1
29	GBAI1013-29	Uzcategui Eyelid Clamp	11.5 cm	Straight	AISI 420 / 440A	Mirror Polish	1
30	GBAI1013-30	Stainless Steel Sterilizing Box	20 × 10 × 5 cm	Straight	AISI 304 / 316L	Mirror Polish	1
				-		TOTAL QUANTITIES	30



Microsurgical Instruments Set-(GBAI-1035)

Sr. #	Code	Instrument Description	Specification	Type	Steel Type	Finish	QTY
01	GBAI1035-01	Scissors, Spring Type	14 cm	Curved	AISI 420	Mirror	1
02	GBAI1035-02	Tweezers, Dumont #5 (Non-Magnetic Stainless Steel)	11 cm	Straight (Fine Tip)	AISI 304	Mirror	1
03	GBAI1035-03	Needle Holder, Castroviejo	14 cm	Straight (Locking)	AISI 420	Satin	1
04	GBAI1035-04	Scissors, Tenotomy	10 cm	Straight	AISI 420	Mirror	1
05	GBAI1035-05	Micro Hemostatic Forceps	12.5 cm	Curved	AISI 410	Satin	2
06	GBAI1035-06	Instrument Tray (Autoclavable)	20 × 10 × 3 cmcm	-----	AISI 304	Polished	1
07	GBAI1035-07	Knife Handle (Round Knurled)	12 cm	Straight	AISI 410	Satin	1
08	GBAI1035-08	Probe (Stainless Steel)	14 cm	Straight	AISI 304	Satin	1
09	GBAI1035-09	Blades, Miniature Edge (Pack of 12)	-----	-----	Carbon Steel	Satin	1
10	GBAI1035-10	Retractor, Weitlaner	10.8 cm	Self-Retaining	AISI 410	Satin	1
						TOTAL QUANTITY	11



MICRO VASCULAR SURGERY SET - (GBAI-1060)

Sr. #	Code	Instrument Description	Specification	Type	Steel Type	Finish	QTY
01	1060-01	Microsurgical Scissors (Spring)	14 cm	Curved	AISI 420	Mirror	1
02	1060-02	Microsurgical Scissors (Spring)	14 cm	Straight	AISI 420	Mirror	1
03	1060-03	Needle Holder, Castroviejo (Lock)	14 cm	Straight	AISI 420	Mirror	1
04	1060-04	Dumont #5 Forceps (Non-magnetic)	11 cm	Straight	Titanium	Matte Blue	1
05	1060-05	Dumont #7 Forceps (Bayonet)	11 cm	Angled	Titanium	Matte Blue	1
06	1060-06	Vessel Dilators (Set)	0.8-2.0 mm	Curved	AISI 420	Satin	1
07	1060-07	Atraumatic Bulldog Clips (Pair)	20-40 g	Vascular	AISI 440A	Satin	2
08	1060-08	Micro Clip Applier	-----	Vascular	AISI 420	Satin	1
09	1060-09	Iris Scissors SuperCut	11.5 cm	Curved	AISI 410	Mirror	1
10	1060-10	Jeweler Forceps #3C	11 cm	Straight	AISI 420	Mirror	1
11	1060-11	Suction Cannula Micro	-----	Bayonet	AISI 410	Satin	1
12	1060-12	Metric Ruler (Flexible)	15 cm	-----	AISI 410	Satin	1
TOTAL QUANTITY							13



Ophthalmic Surgery Set (GBAI-1078)

Sr. #	Code	Instrument Description	Specification	Type	Steel Type	Finish	QTY
01	1078-01	Iris Scissors	11 cm	Curved	AISI 420	Mirror	1
02	1078-02	Westcott Scissors	11 cm	Straight	AISI 420	Mirror	1
03	1078-03	Castroviejo Needle Holder TC	14 cm	Straight	AISI 420	Mirror	1
04	1078-04	Barraquer Forceps, tying	10 cm	Straight	AISI 420	Mirror	1
05	1078-05	Fixation Forceps, 1×2 teeth	10 cm	Straight	AISI 420	Mirror	1
06	1078-06	Eye Speculum, Barraquer	SS wire	Straight	AISI 410	Mirror	1
07	1078-07	Chalazion Clamp	Medium	Straight	AISI 410	Mirror	1
08	1078-08	Lens Expressor	-----	Straight	AISI 410	Mirror	1
09	1078-09	Eye Dressing Scissors	11 cm	Curved	AISI 420	Mirror	1
10	1078-10	Cotton Applicator	15 cm	Straight	AISI 410	Mirror	2
11	1078-11	Lacrimal Probe Set	1-6 Fr	Straight	AISI 420	Mirror	6
12	1078-12	Corneal Knife Handle	-----	Straight	AISI 410	Mirror	1
						TOTAL QUANTITY	18



Dental Examination Set(GBAI-1016)

Sr. #	Code	Instrument Description	Specification	Type	Steel Type	Finish	QTY
01	GBAI1016-01	Dental Mirror	14 cm	-	AISI 420 / 420J2	Mirror Polish	1
02	GBAI1016-02	Dental Explorer (Probe)	16 cm	-	AISI 420 / 420J2	Mirror Polish	1
03	GBAI1016-03	Tweezer	15 cm	-	AISI 410 / 420	Mirror Polish	1
						TOTAL QUANTITY	3



Dental Suture Practice Kit(**GBAI-1017**)

Sr. #	Code	Instrument Description	Specification	Type	Steel Type	Finish	QTY
01	GBAI1017-01	Silicone Dental Suture Pad	-	Flat Pad	Silicone Material (Medical Grade)	Matte Silicone Finish	4
02	GBAI1017-02	Silk Braided Suture Thread with Needle 2/0	-	Straight	Stainless Steel Needle (AISI 304)	Natural Black Silk Thread / Mirror Polished Needle	1
03	GBAI1017-03	Silk Braided Suture Thread with Needle 3/0	-	Straight	Stainless Steel Needle (AISI 304)	Natural Black Silk Thread / Mirror Polished Needle	1
04	GBAI1017-04	Silk Braided Suture Thread with Needle 4/0	-	Straight	Stainless Steel Needle (AISI 304)	Natural Black Silk Thread / Mirror Polished Needle	1
05	GBAI1017-05	Silk Braided Suture Thread with Needle 5/0	-	Straight	Stainless Steel Needle (AISI 304)	Natural Black Silk Thread / Mirror Polished Needle	1
06	GBAI1017-06	Silk Braided Suture Thread with Needle 6/0	-	Straight	Stainless Steel Needle (AISI 304)	Natural Black Silk Thread / Mirror Polished Needle	1
07	GBAI1017-07	Needle Holder, Mayo Hegar	-	Straight	AISI 410 / 420 (for Mayo Hegar)	Mirror Polish	1
08	GBAI1017-08	Adson Forceps 1x2 Teeth	-	Straight	AISI 410 / 420 (for Adson Forceps)	Satin Finish	1
			-			TOTAL QUANTITY	11



Dental Surgery Set-(GBAI-1019)

Sr. #	Code	Instrument Description	Specification	Type	Steel Type	Finish	QTY
01	GBAI1019-01	Adson Forceps 1x2 Teeth, 4 3/4"	4.75"	Serrated	AISI 420	Polished	1
02	GBAI1019-02	Adson Forceps 1x2 Teeth, 4 3/4"	4.75"	Serrated	AISI 420	Polished	1
03	GBAI1019-03	College Plier #2	-----	Straight	AISI 410	Satin	1
04	GBAI1019-04	Bone File Double-End	-----	Double End	AISI 410	Satin	1
05	GBAI1019-05	Explorer Single End, #17	-----	Single End	AISI 420	Satin	1
06	GBAI1019-06	Crile-Wood Needle Holder Tungsten Carbide, Serrated, 6"	6"	Serrated	AISI 410 / TC Insert	Satin	1
07	GBAI1019-07	Gardner Chisel #51	-----	Flat	AISI 410	Satin	1
08	GBAI1019-08	Explorer Single End, #17	-----	Single End	AISI 410	Satin	1
09	GBAI1019-09	Explorer Single End, #23	-----	Single End	AISI 410	Mirror	1
10	GBAI1019-10	La Grange Scissor S-Shape, 4 1/2", 1 Blade Serrated	4.5"	S-Shape	AISI 410	Polished	1
11	GBAI1019-11	Mirror Handle Octagonal, Cone Socket	-----	Octagonal	AISI 410	Satin	1
12	GBAI1019-12	Lucas Curette Double End, #86	-----	Double End	AISI 410	Polished	1
13	GBAI1019-13	Mirror Handle Octagonal, Cone Socket	-----	Octagonal	AISI 410	Satin	1
14	GBAI1019-14	Molt Periosteal Elevator #9	-----	Double End	AISI 410	Polished	1
15	GBAI1019-15	Mouth Mirror Cone Socket, Plane #4	-----	Plane	AISI 410	Polished	1
16	GBAI1019-16	Mouth Mirror Cone Socket, Magnifying, #4	-----	Magnifying	AISI 410	Satin	1
17	GBAI1019-17	Orban Knife Double End, #1/2	-----	Double End	AISI 410	Satin	1
18	GBAI1019-18	Scalpel Handle #3 Fits Blades 10, 11, 12, 15	-----	Standard	AISI 410	Satin	1
19	GBAI1019-19	University of Minnesota Cheek Retractor Double End, 5 1/2"	5.5"	Double End	AISI 420	Polished	1
20	GBAI1019-20	Surgical Blade Carbon, #11	-----	Carbon Steel	AISI 410	Black Finish	1
21	GBAI1019-21	Surgical Blade Carbon, #15	-----	Carbon Steel	AISI 410	Black Finish	1
TOTAL QUANTITY							21



Extraction Forceps and Elevators (GBAI-1022)

Sr. #	Code	Instrument Description	Specification	Type	Steel Type	Finish	QTY
01	GBAI1022-01	Extracting Forceps #23	16 cm	Curved	AISI 420 / 440A	Mirror Polish	1
02	GBAI1022-02	Extracting Forceps #150	16 cm	Curved	AISI 420 / 440A	Mirror Polish	1
03	GBAI1022-03	Extracting Forceps #151	16 cm	Curved	AISI 420 / 440A	Mirror Polish	1
04	GBAI1022-04	Root Elevator Right	13 cm	Curved(Right)	AISI 410 / 420	Mirror Polish	1
05	GBAI1022-05	Root Elevator Left	13 cm	Curved(Left)	AISI 410 / 420	Mirror Polish	1
06	GBAI1022-06	Root Elevator #301	13 cm	Straight	AISI 410 / 420	Mirror Polish	1
07	GBAI1022-07	Dental Mirror #5	14 cm	Straight	AISI 420 / 420J2	Mirror Polish	1
08	GBAI1022-08	College Cotton Plier	15 cm	Straight	AISI 410 / 420	Satin Finish	1
09	GBAI1022-09	Explorer Probe #5	16 cm	Straight	AISI 410 / 420	Mirror Polish	1
						TOTAL QUANTITY	9



Periodontal Surgery Kit-(GBAI-1041)

Sr. #	Code	Instrument Description	Specification	Type	Steel Type	Finish	QTY
01	GBAI1041-01	Periotome (Anterior)	15 cm	Straight, Fine Tip	AISI 420	Mirror	1
02	GBAI1041-02	Periotome (Anterior)	15 cm	Angled	AISI 420	Mirror	1
03	GBAI1041-03	CP12 Periodontal Probe	17 cm	Straight, Double-Ended	AISI 304	Matte	1
04	GBAI1041-04	Periotome (Single Wide Blade)	15 cm	Straight	AISI 420	Mirror	1
05	GBAI1041-05	Molt No. 9 Periosteal Elevator	17 cm	Double-Ended, Sharp/Blunt	AISI 420	Satin	1
06	GBAI1041-06	Prichard Periosteal Elevator	17 cm	Curved	AISI 420	Satin	1
07	GBAI1041-07	TC Universal Wire Cutting Scissors	17 cm	Angled	AISI 420	Satin	1
08	GBAI1041-08	Lucas Bone Curette No. 85	18 cm	Curved, Double-Ended	AISI 420	Mirror	1
09	GBAI1041-09	Lucas Bone Curette No. 89	17 cm	Curved, Double-Ended	AISI 410	Mirror	1
10	GBAI1041-10	Joseph Double Prong Skin Hook	17 cm	Double-Ended	AISI 410	Satin	1
11	GBAI1041-11	Joseph Double Prong Single Hook	Handle 13 cm, Mirror Ø 22 mm	Straight	AISI 304	Satin	1
12	GBAI1041-12	Rhodes Back-Action Chisel	15 cm	Angled	AISI 420	Satin	1
13	GBAI1041-13	Jovanovic Chisel (3 mm Blade)	15 cm	Curved	AISI 410	Satin	1
14	GBAI1041-14	Adson Tissue Forceps (1×2 Teeth)	12 cm (4¾")	Curved	AISI 410	Satin	1
15	GBAI1041-15	Iris Scissors (Straight, Sharp Tips)	15 cm (6")	Angled	AISI 420	Satin	1
16	GBAI1041-16	Jansen Mastoid Retractor 3×3 Teeth	13 cm	Curved Blade	AISI 410	Polished	1
17	GBAI1041-17	Rochester Ochsner Forceps	17 cm	Angled	AISI 410	Mirror	1
18	GBAI1041-18	Gracey Curette 11/12 (Mesial Posterior)	17 cm	Curved	AISI 410	Mirror	1
19	GBAI1041-19	Gracey Curette 18/19 (Mesial Posterior)	17 cm	Curved	AISI 420	Mirror	1
20	GBAI1041-20	U.S. Army Retractor (Double Ended)	21.5 cm (8½")	Straight	AISI 420	Mirror	1
21	GBAI1041-21	Castroviejo Needle Holder (Carbide Tip)	33 × 2.5 cm (13" × 1")	Straight	AISI 420	Mirror	1
22	GBAI1041-22	Corn Suture Pliers	15 cm (6")	Curved	AISI 420	Satin	1
23	GBAI1041-23	Castroviejo Needle Holder (Carbide Tip, Duplicate)	13 cm	Straight	AISI 420	Satin	1
24	GBAI1041-24	Minnesota Retractor	16 cm	Curved Flat	AISI 420	Satin	1
25	GBAI1041-25	SuperCut Iris Scissors (Curved, Fine)	11.5 cm (4½")	Curved	AISI 420	Mirror	1
						TOTAL QUANTITY	25



Home Dental Kit-(GBAI-1027)

Sr. #	Code	Instrument Description	Specification	Type	Steel Type	Finish	QTY
01	GBAI1027-01	Dental Scaler	17 cm	Curved (Double-ended)	AISI 410	Mirror	1
02	GBAI1027-02	Dental Probe / Explorer	16 cm	Straight (Double-ended)	AISI 410	Mirror	1
03	GBAI1027-03	Dental Mouth Mirror Handle	13 cm	Straight	AISI 410	Mirror	1
04	GBAI1027-04	Magnifying Mouth Mirror	Ø 22 mm	Straight	AISI 304	Polished	1
05	GBAI1027-05	Plain Mouth Mirror	Ø 22 mm	Straight	AISI 304	Polished	1
06	GBAI1027-06	Dental Tweezers	15 cm	Straight	AISI 410	Mirror	1
07	GBAI1027-07	Free Storage Pouch	-	-----	Synthetic Fabric	-----	1
TOTAL QUANTITY							7



Dental & Oral Surgery Set (GBAI-1075)

Sr. #	Code	Instrument Description	Specification	Type	Steel Type	Finish	QTY
01	1075-01	Extraction Forceps	#1 upper anterior	Curved	AISI 420	Mirror	1
02	1075-02	Extraction Forceps	#16 upper anterior	Curved	AISI 420	Mirror	1
03	1075-03	Extraction Forceps	#17 upper anterior	Curved	AISI 420	Mirror	1
04	1075-04	Root Elevator	straight	Straight	AISI 410	Satin	1
05	1075-05	Root Elevator	cryer L & R	Curved	AISI 410	Satin	2
06	1075-06	Periosteal Elevator	15 cm	Straight	AISI 410	Satin	1
07	1075-07	Bone Rongeur	14 cm	Curved	AISI 420	Mirror	1
08	1075-08	Needle Holder, Mathieu	14 cm	Straight	AISI 410	Satin	1
09	1075-09	Tissue Forceps	1x2 teeth	Straight	AISI 410	Satin	1
10	1075-10	Scalpel Handle	No. 3	Straight	AISI 410	Satin	1
11	1075-11	Tongue Depressor	16 cm	Straight	AISI 410	Mirror	1
12	1075-12	Mouth Gag, Jennings	Medium	Straight	AISI 410	Satin	1
						TOTAL QUANTITY	13



Av Fistula Instruments Set-(GBAI-1007)

Sr. #	Code	Instrument Description	Specification	Type	Steel Type	Finish	QTY
01	GBAI1007-01	Medicine Cup Graduated Measure	2 Oz	-	AISI 304	Mirror Polish	1
02	GBAI1007-02	Scalpel Handle	#3	-	AISI 410 / 420A	Mirror Polish	2
03	GBAI1007-03	Scalpel Handle	#9	-	AISI 410 / 440A	Mirror Polish	1
04	GBAI1007-04	Ruskin Rongeur Straight Double Action	17 CM	STRAIGHT	AISI 410 + Tungsten Carbide (TC) Blades	Satin Finish (TC edges)	1
05	GBAI1007-05	Joseph Hook Sharp Single Prong	14 CM	CURVED	AISI 410 + Tungsten Carbide (TC) Blades	Satin Finish (TC edges)	1
06	GBAI1007-06	Joseph Double Prong Skin Hook	12.5 CM	STRAIGHT	AISI 410 / 420	Mirror Polish	4
07	GBAI1007-07	Halsted Mosquito Forceps	12.5 CM	CURVED	AISI 410 / 420	Satin Finish	10
08	GBAI1007-08	Halsted Mosquito Forceps	16 CM	CURVED	AISI 420 / 420J2	Satin Finish	6
09	GBAI1007-09	Micro-Mosquito Forceps Delicate	16 CM	CURVED	AISI 420 / 420J2	Mirror Polish	4
10	GBAI1007-10	Rochester-Ochsner Forceps 1x2 Teeth	16 CM	STRAIGHT	AISI 420A	Mirror Polish	2
11	GBAI1007-11	TC Halsey Needle Holder Serrated	12 CM	-	AISI 410 + TC Jaws	Satin Finish (TC jaws)	1
12	GBAI1007-12	TC Baby Crile-Wood Needle Holders Serrated	12 CM	-	AISI 410 + TC Jaws	Satin Finish (TC jaws)	2
13	GBAI1007-13	Luer Rongeur Single Action	18 CM	CURVED	AISI 410 / 420	Mirror Polish	10
14	GBAI1007-14	TC Castroviejo Needle Holders Straight with Lock	16 CM	-	AISI 410 + TC Jaws	Satin Finish (TC jaws)	2
15	GBAI1007-15	Weitlaner Retractor 2x3 Teeth, Blunt	12 CM	-	AISI 410 + TC Jaws	Satin Finish (TC jaws)	1
16	GBAI1007-16	Alm Retractor 2x2 Teeth, Blunt	15 CM	-	AISI 420 / 440A	Mirror Polish	1
17	GBAI1007-17	Alm Retractor 4x4 Teeth, Blunt	12 CM	-	AISI 420 / 440A	Mirror Polish	2
18	GBAI1007-18	Mixter Forceps Right Angle	18 CM	-	AISI 420 / 440A	Mirror Polish	2
19	GBAI1007-19	Allis Tissue ForcePS 4x5 TeethH	18 CM	-	AISI 420 / 440A	Mirror Polish	2
20	GBAI1007-20	Gillies Skin Hooks 4mm	18 CM	-	AISI 420A	Satin Finish	1
21	GBAI1007-21	Knife Rochester-Pean Forcep	18 CM	CURVED	AISI 420 / 420J2	Mirror Polish	1
22	GBAI1007-22	Allis Tissue 4 x 5 Teeth	14 CM	-	AISI 410 / 420	Satin Finish	2
23	GBAI1007-23	Lorna-Edna Towel Clamps	18 CM	-	AISI 410 / 420	Mirror Polish	2
24	GBAI1007-24	Frazier Suction Tube	8 Fr	-	AISI 304	Mirror Polish	1

Av Fistula Instruments Set-(GBAI-1007)

Sr. #	Code	Instrument Description	Specification	Type	Steel Type	Finish	QTY
25	GBAI1007-25	Adson Tissue Forceps 1x2 Teeth	12 CM	-	AISI 420 / 420J2	Mirror Polish	2
26	GBAI1007-26	Adson Dressing Forceps Serrated	12 CM	-	AISI 410 / 420	Mirror Polish	2
27	GBAI1007-27	TC Potts-Smith Dressing Forcep Serrated	18 CM	-	AISI 410 + TC Serrated Jaws	Satin Finish (TC serrated jaws)	1
28	GBAI1007-28	Debakey Atraumatic Forceps 2mm	16 CM	-	AISI 420 / 420J2	Satin Finish	2
29	GBAI1007-29	Bulldog DeBakey Atraumatic Forceps	12.5 CM	-	AISI 420A	Mirror Polish	2
30	GBAI1007-30	Bulldog DeBakey Atraumatic Forceps	12.5 CM	CURVED	AISI 420A	Mirror Polish	2
31	GBAI1007-31	Bulldog DeBakey Atraumatic Forceps	12.5 CM	-	AISI 420 / 440A	Satin Finish	2
32	GBAI1007-32	Bulldog DeBakey Atraumatic Forceps Ring Handle, 45° Angle	-	-	AISI 420 / 440A	Satin Finish	1
33	GBAI1007-33	Garrett Vascular Dilator Set 8 1/2", Set of 9	24 CM	-	AISI 420 / 440A	Satin Finish	2
34	GBAI1007-34	Richardson Retractors Grip Handle, Small	23 CM	-	AISI 420 / 440A	Mirror Polish	1
35	GBAI1007-35	US Army Retractor Set of 2, Double End	16 CM	-	AISI 420 / 440A	Mirror Polish	2
36	GBAI1007-36	Senn Retractors Double End, Blunt, 3 Prongs	11 CM	-	AISI 420 / 440A	Mirror Polish	1
37	GBAI1007-37	Single Cannula (2 included with set)	12.5 CM	-	AISI 420 / 440A	Mirror Polish	1
38	GBAI1007-38	Cannula Bender	14MM	-	AISI 410 / 420	Satin Finish	2
39	GBAI1007-39	Tendon Stripper, Closed end, 6mm	3MM	-	AISI 316L	Satin Finish	1
40	GBAI1007-40	Graphical CPS-e For Meniscal Repair Set	26 CM	CURVED	AISI 410 / 420	Mirror Polish	1
41	GBAI1007-41	Diethrich Bulldog Clamps Angled	8MM	-	AISI 420A	Mirror Polish	4
42	GBAI1007-42	DeBakey Vascular Scissor 45° Angle	18CM	-	AISI 420 / 440A	Satin Finish	1
						TOTAL QUANTITY	93



Thoracotomy Instrument Set-(GBAI-1048)

Sr. #	Code	Instrument Description	Specification	Type	Steel Type	Finish	QTY
01	GBAI1048-01	Freer Elevator, Double-Ended, Blunt/Sharp Blades	19.5 cm (7 ¾")	Straight / Double End	AISI 420	Satin	1
02	GBAI1048-02	DeBakey Vascular Tissue Forceps, 1.5 mm Tips	20 cm (8")	Straight	AISI 420	Mirror	2
03	GBAI1048-03	Martin Tissue Forceps, 7x8 Teeth	19.5 cm (7 ¾")	Straight	AISI 410	Satin	1
04	GBAI1048-04	Knife Handle No. 3	14 cm (5 ½")	Straight	AISI 420	Mirror	1
05	GBAI1048-05	New Orleans Needle Holder	18 cm (7")	Straight	AISI 420 + TC	Mirror	1
06	GBAI1048-06	Doyen Rib Elevator & Rasp Right	17 cm (7")	Right-Angled	AISI 410	Satin	1
07	GBAI1048-07	Doyen Rib Elevator & Rasp Left	17 cm (7")	Left-Angled	AISI 410	Satin	1
08	GBAI1048-08	Mixer Thoracic Forceps Right Angle Jaws	28 cm (11")	Right-Angled	AISI 410	Satin	2
09	GBAI1048-09	Sauerbruch Rongeur	30 cm (12")	Curved	AISI 410	Mirror	1
10	GBAI1048-10	Kelly Hemostatic Forceps	14 cm (5 ½")	Curved	AISI 410	Satin	12
11	GBAI1048-11	Matson Rib Elevator	22 cm (8 ¾")	Straight	AISI 410	Satin	1
12	GBAI1048-12	Volkman Retractor 4 Prongs Blunt	21.5 cm (8 ½")	Blunt	AISI 420	Satin	2
13	GBAI1048-13	Burford Finochietto Rib Spreader (Aluminum)	25 cm (10") Spread	Retractor / Adjustable	Aluminum (6061-T6)	Anodized Silver	1
14	GBAI1048-14	Bailey Rib Contractor Standard	Standard	Rack Type	AISI 410	Satin	1
15	GBAI1048-15	Allison Lung Retractor	32 cm (12 ¾")	Spoon Type	AISI 420	Mirror	1
16	GBAI1048-16	Collin Duval Lung Grasping Forceps 1" Jaws	23 cm (9")	Curved Right	AISI 420	Satin	2
17	GBAI1048-17	DeBakey Multipurpose Clamp 60° 5 cm Jaws	12 cm (4.75")	Angled 60°	AISI 420	Mirror	2
18	GBAI1048-18	Alexander Farabeuf Periosteotome	20 cm (8")	Straight	AISI 420	Satin	1
19	GBAI1048-19	Lindo-Levien Elevator (Right, Serrated)	21.5 cm (8 ½")	Curved	AISI 420	Satin	1
20	GBAI1048-20	Ribbon Retractor Malleable 1.25"	33 cm (13")	Straight	AISI 420 + TC	Mirror	1
21	GBAI1048-21	Metzenbaum Scissors T.C.	18 cm (7")	Curved	AISI 420 + TC	Mirror	1
22	GBAI1048-22	Metzenbaum Scissors T.C.	23 cm (9")	Curved	AISI 410	Mirror	1
23	GBAI1048-23	Coller Crile Forceps	16 cm (6 ¼")	Curved	AISI 420 + TC	Satin	1
24	GBAI1048-24	Potts-Smith Forceps Cross Serrated T.C.	23 cm (9")	Straight	AISI 410	Mirror	1

Thoracotomy Instrument Set-(GBAI-1048)

Sr. #	Code	Instrument Description	Specification	Type	Steel Type	Finish	QTY
25	GBAI1048-25	Backhaus Towel Clamp	13 cm (5 ¼")	Curved	AISI 420 + TC	Mirror	12
26	GBAI1048-26	Crile-Wood Needle Holder T.C	20 cm (8")	Straight	AISI 420 + TC	Mirror	12
27	GBAI1048-27	Ryder Needle Holder T.C.	26 cm (10 ¼")	Straight	AISI 410	Satin	1
28	GBAI1048-28	Ribbon Retractor Malleable ¾"	33 cm (13")	Flat / Bendable	AISI 420 + TC	Mirror	1
29	GBAI1048-29	Mayo-Hegar Needle Holder T.C.	26.5 cm (10 ½")	Curved	AISI 304 (Suction Tube)	Mirror	1
30	GBAI1048-30	Yankauer Suction Tube 20 Fr Standard	Standard	Straight	AISI 410	Satin	1
31	GBAI1048-31	Ribbon Retractor Malleable 2"	33 cm (13")	Flat / Bendable	AISI 410	Satin	1
32	GBAI1048-32	Richardson Retractor Loop Handle 1" x ¾"	24 cm (9 ½")	Curved Blade	AISI 410	Satin	1
33	GBAI1048-33	Richardson Retractor Loop Handle 1½" x 1½"	24 cm(9 ½")	Curved Blade	AISI 410	Satin	1
34	GBAI1048-34	Kelly Retractor Loop Handle 2" x 1½"	25 cm (9 ¾")	Curved	AISI 410	Satin	1
35	GBAI1048-35	Kelly Retractor Loop Handle 2" x 1½"	25 cm (9 ¾")	Curved	AISI 410	Satin	1
36	GBAI1048-36	Harrington Retractor 2½" Blade	30 cm (12")	Curved	AISI 410	Satin	1
37	GBAI1048-37	Harrington Retractor 2½" Blade	30 cm (12")	Curved	AISI 410	Satin	1
38	GBAI1048-38	Volkman Retractor 6 Prongs Sharp	21.5 cm (8 ½")	Sharp	AISI 410	Mirror	2
						TOTAL QUANTITY	77



Vascular Surgery Instruments Set-(GBAI-1053)

Sr. #	Code	Instrument Description	Specification	Type	Steel Type	Finish	QTY
01	GBAI1053-01	Mayo Dissecting Scissors	17 cm (6 ¾")	Straight	AISI 420	Mirror	1
02	GBAI1053-02	Mayo Dissecting Scissors T.C	17 cm (6 ¾")	Straight	AISI 420 + TC	Mirror	1
03	GBAI1053-03	Mayo Dissecting Scissors	17 cm (6 ¾")	Curved	AISI 420	Mirror	1
04	GBAI1053-04	Operating Scissors Sharp/Blunt	14 cm (5½")	Straight	AISI 410	Mirror	1
05	GBAI1053-05	Mayo Dissecting Scissors T.C.	17 cm (6 ¾")	Curved	AISI 420 + TC	Mirror	1
06	GBAI1053-06	Metzenbaum Scissors Delicate T.C.	17 cm (6¾")	Curved	AISI 420 + TC	Mirror	2
07	GBAI1053-07	Metzenbaum Scissors Delicate	18 cm (7")	Curved	AISI 420	Mirror	2
08	GBAI1053-08	Metzenbaum-Nelson Dissecting Scissors	18 cm (7")	Curved	AISI 420	Mirror	1
09	GBAI1053-09	Metzenbaum Dissecting Scissors Delicate	20 cm (8")	Curved	AISI 420	Mirror	1
10	GBAI1053-10	Metzenbaum Dissecting Scissors T.C.	23 cm (9")	Curved	AISI 420 + TC	Mirror	1
11	GBAI1038-11	Metzenbaum Dissecting Scissors T.C.	23 cm (9")	Angled	AISI 420 + TC	Mirror	1
12	GBAI1053-12	Suture Wire Cutting Scissors	12 cm (4 ¾")	Angled	AISI 420	Mirror	1
13	GBAI1053-13	Halsted Mosquito Forceps	12 cm (4 ¾")	Curved	AISI 410	Mirror	6
14	GBAI1053-14	Crile Forceps	12.5 cm (5")	Curved	AISI 410	Satin	6
15	GBAI1053-15	Rochester-Ochsner Forceps (1×2 Teeth)	14 cm (5 ½")	Curved	AISI 410	Satin	6
16	GBAI1053-16	Rochester Ochsner Forceps 1×2 Teeth	16 cm (6¼")	Curved	AISI 410	Satin	6
17	GBAI1053-17	Rochester Ochsner Forceps 1×2 Teeth	16 cm (6¼")	Straight	AISI 410	Satin	6
18	GBAI1053-18	Dressing Forceps (Serrated)	16 cm (6¼")	Straight	AISI 410	Satin	2
19	GBAI1053-19	Backhaus Towel Clamp	13 cm (5 ¼")	Curved	AISI 410	Satin	8
20	GBAI1053-20	Scalpel Handle #7	14 cm (5½")	Straight	AISI 410	Satin	2
21	GBAI1038-21	Scalpel Handle #3	14 cm (5 ½")	Straight	AISI 410	Satin	4
22	GBAI1053-22	Scalpel Handle #3L (Long)	16 cm (6 ¼")	Straight	AISI 410	Satin	2
23	GBAI1053-23	Foerster Sponge Forceps Serrated	24 cm (9 ½")	Straight	AISI 410	Satin	6
24	GBAI1053-24	Mayo-Hegar Needle Holder	15 cm (6")	Straight	AISI 410	Satin	4

Vascular Surgery Instruments Set-(GBAI-1053)

Sr. #	Code	Instrument Description	Specification	Type	Steel Type	Finish	QTY
25	GBAI1053-25	Mayo-Hegar Needle Holder T.C.	15 cm (6")	Straight	AISI 410 + TC	Satin	4
26	GBAI1053-26	Mayo-Hegar Needle Holder	18 cm (7")	Straight	AISI 410	Satin	4
27	GBAI1053-27	Mayo-Hegar Needle Holder T.C.	20 cm (8")	Straight	AISI 410 + TC	Satin	4
28	GBAI1053-28	Mayo-Hegar Needle Holder	20 cm (8")	Straight	AISI 410	Satin	2
29	GBAI1053-29	Mayo-Hegar Needle Holder T.C.	14 cm (5 ½")	Straight	AISI 410 + TC	Satin	2
30	GBAI1053-30	Tissue Forceps 1×2 Teeth	20 cm (8")	Straight	AISI 410	Satin	2
31	GBAI1053-31	Tissue Forceps 1×2 Teeth	20 cm (8")	Straight	AISI 410	Satin	1
32	GBAI1053-32	Dressing Forceps Serrated	16 cm (6¼")	Straight	AISI 410	Satin	2
33	GBAI1053-33	Dressing Forceps Serrated	20 cm (8")	Straight	AISI 410	Satin	2
34	GBAI1053-34	Adson Tissue Forceps 1×2 Teeth	15 cm (6")	Straight	AISI 410	Satin	2
35	GBAI1053-35	Allis Tissue Forceps 5×6 Teeth	14 cm (5 ½")	Straight	AISI 410	Satin	2
36	GBAI1038-36	Allis Tissue Forceps 5×6 Teeth	12 cm (4 ¾")	Straight	AISI 410	Satin	2
37	GBAI1053-37	Allis-Adair Forceps 9×10 Teeth	19 cm (7 ½")	Straight	AISI 410	Satin	6
38	GBAI1053-38	Babcock Forceps	15 cm (6")	Straight	AISI 410	Satin	2
39	GBAI1053-39	Mixer Forceps Right Angle	16.5 cm (6 ½")	Right-Angled	AISI 410	Satin	2
40	GBAI1053-40	Gemini Clamp Delicate Angled	16.5 (6 ½")	Angled	AISI 410	Satin	4
41	GBAI1053-41	Gemini Clamp Delicate Angled	18.5 cm (7 ¼")	Right-Angled	AISI 410	Satin	4
42	GBAI1053-42	Poole Suction Tube with Slip-On End	16 cm (6 ¼")	Straight	AISI 410	Satin	1
43	GBAI1053-43	Poole Suction Tube with Slip-On End	20 cm (8")	Curved	AISI 410	Satin	2
44	GBAI1053-44	Senn Retractor Double End Sharp	30 Fr	Sharp	AISI 410	Satin	1
45	GBAI1053-45	Yankauer Suction Tube	23 Fr	Straight	AISI 410	Satin	1
46	GBAI1053-46	US Army Retractor Double End (Set of 2)	16 cm (6 ¼")	Double End	AISI 410	Satin	1
47	GBAI1038-47	Roux Retractor Double End (Set of 3)	Standard	Double End	AISI 410	Satin	1
48	GBAI1053-48	Green Retractor Fenestrated	21 cm (8 ¼")	Curved	AISI 410	Satin	1
49	GBAI1053-49	Cushing Nerve & Vein Retractor	18.5 cm (7¼")	Curved	AISI 410	Satin	2
50	GBAI1053-50	Richardson Retractor Small Blade	24 cm (9 ½")	Curved	AISI 410	Satin	2
51	GBAI1053-51	Richardson Retractor Medium Blade	24 cm (9 ½")	Curved	AISI 410	Satin	2
52	GBAI1053-52	Richardson Retractor Large Blade	24 cm (9 ½")	Curved	AISI 410	Satin	2
53	GBAI1053-53	Deaver Retractor #1 (1")	30 cm (12")	Curved	AISI 410	Satin	2
54	GBAI1053-54	Deaver Retractor #3 (1½")	30 cm (12")	Curved	AISI 410	Satin	1
55	GBAI1053-55	Deaver Retractor #4 (2")	30 cm (12")	Curved	AISI 410	Satin	1
56	GBAI1053-56	Deaver Retractor #5 (3", Grip Handle)	8 Fr	Curved	AISI 410	Satin	1
57	GBAI1053-57	Zalkind Ribbon Retractor Malleable	2.5 cm × 33 cm (1" × 13")	Flat / Bendable	AISI 410	Satin	1
58	GBAI1053-58	Zalkind Ribbon Retractor Malleable	3.8 cm × 33 cm (1" × 13")	Flat / Bendable	AISI 410	Satin	4
59	GBAI1053-59	Zalkind Ribbon Retractor Malleable	6.5 cm × 33 cm (1" × 13")	Flat / Bendable	AISI 410	Satin	4
60	GBAI1053-60	Weitlaner Retractor 3×4 Teeth Sharp	16.5 cm (6 ½")	Sharp / Self-Retaining	AISI 410	Satin	2
61	GBAI1053-61	Volkman Retractor 4 Prong Blunt	21.5 cm (8 ½")	Blunt	AISI 410	Satin	2
62	GBAI1053-62	Adson Forceps Half-Serrated Jaw	18.5 cm (7 ¼")	Straight	AISI 410	Satin	2
63	GBAI1053-63	Adson Forceps Half-Serrated Jaw	18.5 cm (7 ¼")	Curved	AISI 410	Satin	4
64	GBAI1053-64	Crafoord Forceps Serrated	18 cm (7")	Curved	AISI 410	Satin	4
						TOTAL QUANTITY	163



Vasectomy Instrument Set-(GBAI-1054)

Sr. #	Code	Instrument Description	Specification	Type	Steel Type	Finish	QTY
01	GBAI1054-01	Scalpel Handle #3	14 cm (5 ½")	Straight	AISI 410	Satin	1
02	GBAI1054-02	Iris Scissors	11.5 cm (4 ½")	Straight	AISI 420	Mirror	1
03	GBAI1054-03	Iris Scissors	11.5 cm (4 ½")	Curved	AISI 420	Mirror	1
04	GBAI1054-04	Adson Dressing Forceps Serrated	12 cm (4 ¾")	Straight	AISI 410	Satin	1
05	GBAI1054-05	Adson Tissue Forceps 1x2 Delicate	12 cm (4 ¾")	Straight	AISI 410	Satin	1
06	GBAI1054-06	Metzenbaum Scissors (Standard) T.C.	18 cm (7")	Curved	AISI 420 + TC (Tungsten Carbide)	Mirror	1
07	GBAI1054-07	Halsted Mosquito Forceps	12.5 cm (5")	Straight	AISI 410	Satin	1
08	GBAI1054-08	Halsted Mosquito Forceps	12.5 cm (5")	Curved	AISI 410	Satin	2
09	GBAI1054-09	Mayo-Hegar Needle Holder T.C.	14 cm (5 ½")	Serrated	AISI 410 + TC (Tungsten Carbide)	Satin	1
10	GBAI1054-10	Allis Tissue Forceps 4x5 Teeth	13 cm (5")	Straight	AISI 410	Satin	1
11	GBAI1054-11	Backhaus Towel Clamp	9 cm (3 ½")	Curved	AISI 410	Satin	4
						TOTAL QUANTITY	15



CARDIAC VASCULAR SURGERY SET - (1058)

Sr. #	Code	Instrument Description	Specification	Type	Steel Type	Finish	QTY
01	1058-01	DeBakey Vascular Forceps	20 cm, 1.5 mm tips	Straight	AISI 420	Satin	2
02	1058-02	Cooley Vascular Scissors	18 cm	Curved	AISI 420	Satin	1
03	1058-03	Potts-Smith Scissors	19 cm, 45°	Angled	AISI 420	Mirror	1
04	1058-04	Bulldog Clamps (Atraumatic)	Small/Medium	Vascular	AISI 440A	Satin	2
05	1058-05	Satinsky Vascular Clamp	24 cm	Angled	AISI 420	Satin	1
06	1058-06	DeBakey Atraumatic Clamp	23 cm	Straight	AISI 420	Satin	1
07	1058-07	Castroviejo Needle Holder (Fine)	14 cm	Straight	AISI 420	Satin	1
08	1058-08	Micro Suturing Forceps (0.3 mm)	15 cm	Straight	AISI 420	Satin	1
09	1058-09	Suction Cannula (Cardiac)	-----	Angled	AISI 410	Mirror	1
10	1058-10	Vascular Dilators (Set)	1-5 mm	Tapered	AISI 420	Satin	1
11	1058-11	Tape / Vessel Loops (Pair)	-----	Silicone	----	-----	1
TOTAL QUANTITY							16



Cardiovascular Surgery Set (GBAI-1072)

Sr. #	Code	Instrument Description	Specification	Type	Steel Type	Finish	QTY
01	1072-01	Vascular Clamp, Cooley, angled	150 mm	Angled	AISI 420	Satin	2
02	1072-02	DeBakey Atraumatic Forceps	200 mm	Straight	AISI 420	Satin	2
03	1072-03	Potts-Smith Scissors	45° / 125 mm	Angled	AISI 420	Satin	2
04	1072-04	Bulldog Clamp, medium	40 mm	Straight	AISI 410	Satin	4
05	1072-05	Bulldog Clamp, small	25 mm	Straight	AISI 410	Satin	4
06	1072-06	Micro Needle Holder, TC Tip	180 mm	Straight	AISI 410 + TC (Tungsten Carbide)	Satin	2
07	1072-07	Vein Retractor	20 mm x 60 mm	Curved	AISI 410	Satin	1
08	1072-08	Vascular Dilator Set	1-6 mm	Straight	AISI 410	Satin	1 set
09	1072-09	Vessel Loop (silicone)	Red / Blue	-----	Silicone (Medical Grade)	-----	2
10	1072-10	Aortic Punch	4 mm	Straight	AISI 410	Mirror	1
11	1072-11	Scissors, Metzenbaum	180 mm	Curved	AISI 410	Satin	2
12	1072-12	DeBakey Satinsky Clamp	210 mm	Angled	AISI 410	Satin	1
						TOTAL QUANTITY	23



Bakes Dilator Set-(GBAI-1008)

Sr. #	Code	Instrument Description	Specification	Type	Steel Type	Finish	QTY
01	GBAI1008-01	Bakes Dilator	1 MM	-	AISI 420 / 440A	MIRROR	1
02	GBAI1008-02	Bakes Dilator	2 MM	-	AISI 420 / 440A	MIRROR	1
03	GBAI1008-03	Bakes Dilator	3 MM	CURVED	AISI 420 / 440A	MIRROR	1
04	GBAI1008-04	Bakes Dilator	4 MM	-	AISI 420 / 440A	MIRROR	1
05	GBAI1008-05	Bakes Dilator	5 MM	-	AISI 420 / 440A	MIRROR	1
06	GBAI1008-06	Bakes Dilator	6 MM	-	AISI 420 / 440A	MIRROR	2
07	GBAI1008-07	Bakes Dilator	7 MM	-	AISI 420 / 440A	MIRROR	1
08	GBAI1008-08	Bakes Dilator	8 MM	-	AISI 420 / 440A	MIRROR	1
09	GBAI1008-09	Bakes Dilator	9 MM	-	AISI 420 / 440A	MIRROR	1
10	GBAI1008-10	Bakes Dilator	10 MM	-	AISI 420 / 440A	MIRROR	1
11	GBAI1008-11	Bakes Dilator	11 MM	-	AISI 420 / 440A	MIRROR	1
12	GBAI1008-12	Bakes Dilator	12 MM	-	AISI 420 / 440A	MIRROR	1
13	GBAI1008-13	Bakes Dilator	13 MM	-	AISI 420 / 440A	MIRROR	1
			-				



Urethral Sound Kit-(GBAI-1052)

Sr. #	Code	Instrument Description	Specification	Type	Steel Type	Finish	QTY
01	GBAI1052-01	Urethral Sound	29 cm (11 1/2") / 18 FR (6.0 mm)	Straight	AISI 410	MIRROR	1
02	GBAI1052-02	Urethral Sound	29 cm (11 1/2") / 18 FR (6.6 mm)	Straight	AISI 410	MIRROR	1
03	GBAI1052-03	Urethral Sound	29 cm (11 1/2") / 18 FR (7.3 mm)	Straight	AISI 410	MIRROR	1
04	GBAI1052-04	Urethral Sound	29 cm (11 1/2") / 18 FR (8.0 mm)	Straight	AISI 410	MIRROR	1
05	GBAI1052-05	Urethral Sound	29 cm (11 1/2") / 18 FR (8.6 mm)	Straight	AISI 410	MIRROR	1
06	GBAI1052-06	Urethral Sound	29 cm (11 1/2") / 18 FR (9.3 mm)	Straight	AISI 410	MIRROR	1
07	GBAI1052-07	Urethral Sound	29 cm (11 1/2") / 18 FR (10.0 mm)	Straight	AISI 410	MIRROR	1
08	GBAI1052-08	Urethral Sound	29 cm (11 1/2") / 18 FR (10.6 mm)	Straight	AISI 410	MIRROR	1
TOTAL QUANTITY							8



UROLOGY OPEN SURGERY SET - (GBAI-1062)

Sr. #	Code	Instrument Description	Specification	Type	Steel Type	Finish	QTY
01	1062-01	Babcock Intestinal Forceps	6¼" (16 cm)	Straight	AISI 420	Satin	2
02	1062-02	Allis Tissue Forceps 5x6	6" (15 cm)	Straight	AISI 420	Satin	2
03	1062-03	Crile Hemostatic Forceps	5½" (14 cm)	Curved	AISI 420	Satin	6
04	1062-04	Kelly Hemostatic Forceps	5½" (14 cm)	Curved	AISI 420	Satin	6
05	1062-05	Mayo Scissors	6¾" (17 cm)	Straight	AISI 420	Satin	1
06	1062-06	Metzenbaum Scissors	7" (18 cm)	Curved	AISI 420	Satin	1
07	1062-07	Foerster Sponge Forceps Serrated	9½" (24 cm)	Straight	AISI 410	Satin	2
08	1062-08	DeBakey Tissue Forceps	8" (20 cm), 1.5 mm tips	Straight	AISI 420	Satin	1
09	1062-09	Adson Tissue Forceps 1x2	4¾" (12 cm)	Straight	AISI 420	Satin	1
10	1062-10	Balfour Abdominal Retractor (Mini)	5" spread	Self-Retaining	AISI 410	Satin	1
11	1062-11	Ribbon Retractor (Malleable)	1" x 13" (25 x 330 mm)	Bendable	AISI 410	Satin	1
12	1062-12	Ribbon Retractor (Malleable)	1½" x 13" (38 x 330 mm)	Bendable	AISI 410	Satin	1
13	1062-13	US Army Retractor (Set of 2)	8¼" (21 cm)	Double-Ended	AISI 410	Satin	1
14	1062-14	Yankauer Suction (SS)	20 Fr	Curved	AISI 410	Satin	1
15	1062-15	Poole Suction Tube	23 Fr	Straight	AISI 410	Satin	1
16	1062-16	Mayo-Hegar Needle Holder	7" (18 cm)	Straight	AISI 410	Satin	2
17	1062-17	Scalpel Handle #3	5½" (14 cm)	Straight	AISI 410	Satin	1
18	1062-18	Scalpel Handle #3	5½" (14 cm)	Straight	AISI 410	Satin	1
19	1062-19	Backhaus Towel Clamp	5½" (13 cm)	Curved	AISI 410	Satin	6
20	1062-20	Dressing Forceps Serrated	8" (20 cm)	Straight	AISI 420	Satin	2
TOTAL QUANTITY							40



BALFOUR ABDOMINAL SET - (GBAI-1064)

Sr. #	Code	Instrument Description	Specification	Type	Steel Type	Finish	QTY
01	1064-01	Balfour Abdominal Retractor (Standard Frame)	7" spread	Self-Retaining	AISI 410	Satin	2
02	1064-02	Balfour Blades, Side (Pair)	75 × 38 mm	Blades	AISI 410	Satin	2
03	1064-03	Balfour Blades, Side (Pair)	100 × 38 mm	Blades	AISI 410	Satin	6
04	1064-04	Balfour Center Blade (Infant)	38 × 38 mm	Blade	AISI 410	Satin	6
05	1064-05	Balfour Center Blade (Adult)	60 × 60 mm	Blade	AISI 410	Satin	1
06	1064-06	Deaver Retractor #0	1" × 12" (25 × 300 mm)	Curved	AISI 410	Satin	1
07	1064-07	Deaver Retractor #3	1½" × 12" (38 × 300 mm)	Curved	AISI 410	Satin	2
08	1064-08	Richardson Retractor Small	¾" × 1" blade, 9½"	Curved	AISI 410	Satin	1
09	1064-09	Richardson Retractor Medium	1" × 1¼" blade, 9½"	Curved	AISI 410	Satin	1
10	1064-10	Richardson Retractor Large	1½" × 1½" blade, 9½"	Curved	AISI 410	Satin	1
11	1064-11	US Army Retractor (Set of 2)	8¼" (21 cm)	Double-Ended	AISI 410	Satin	1
12	1064-12	Schmidt Tonsil Hemostat	7½" (19 cm)	Curved	AISI 420	Satin	1
13	1064-13	Foerster Sponge Forceps Serrated	9½" (24 cm)	Straight	AISI 410	Satin	1
14	1064-14	Backhaus Towel Clamp	5¼" (13 cm)	Curved	AISI 410	Satin	1
15	1064-15	Metzenbaum Scissors	7" (18 cm)	Curved	AISI 420	Satin	1
16	1064-16	Mayo Scissors	6¾" (17 cm)	Straight	AISI 420	Satin	2
17	1064-17	Crile Hemostatic Forceps	5½" (14 cm)	Curved	AISI 420	Satin	1
18	1064-18	Kelly Hemostatic Forceps	5½" (14 cm)	Curved	AISI 420	Satin	1
19	1064-19	Adson Tissue Forceps 1×2	4¾" (12 cm)	Straight	AISI 420	Satin	6
20	1064-20	Mayo-Hegar Needle Holder	7" (18 cm)	Straight	AISI 420	Satin	2
TOTAL QUANTITY							41



Balfour Abdominal Retractor Set - (GBAI-1067)

Sr. #	Code	Instrument Description	Specification	Type	Steel Type	Finish	QTY
01	1067-01	Balfour abdominal retractor frame, standard	55 cm	Frame Type	AISI 410	Satin	1
02	1067-02	Side blades pair, small	30 × 40 mm	Curved Blade	AISI 410	Satin	1
03	1067-03	Side blades pair, medium	35 × 60 mm	Curved Blade	AISI 410	Satin	1
04	1067-04	Side blades pair, large	45 × 80 mm	Curved Blade	AISI 410	Satin	1
05	1067-05	Center blade, infant	25 × 50 mm	Curved Blade	AISI 410	Satin	1
06	1067-06	Center blade, adult	35 × 75 mm	Curved Blade	AISI 410	Satin	1
07	1067-07	Center blade, deep	40 × 90 mm	Curved Blade	AISI 410	Satin	1
08	1067-08	Bladder blade attachment	50 × 120 mm	Curved Blade	AISI 410	Satin	1
09	1067-09	Deaver retractor #0 (1" × 12")	25 × 300 m	Curved Blade	AISI 410	Satin	1
10	1067-10	Deaver retractor #3 (1½" × 12")	38 × 300 m	Curved Blade	AISI 410	Satin	1
11	1067-11	Deaver retractor #4 (2" × 12")	50 × 300 m	Curved Blade	AISI 410	Satin	1
12	1067-12	Richardson retractor small	25 × 60 mm	Curved Blade	AISI 410	Satin	1
13	1067-13	Richardson retractor medium	30 × 80 mm	Curved Blade	AISI 410	Satin	1
14	1067-14	Richardson retractor large	40 × 100 mm	Curved Blade	AISI 410	Satin	1
15	1067-15	US Army retractor (set of 2)	22 × 230 mm	Double Ende	AISI 410	Satin	2
16	1067-16	Malleable ribbon retractor 1" × 13"	25 × 330 mm	Malleable	AISI 410	Satin	1
17	1067-17	Malleable ribbon retractor 1½" × 13"	38 × 330 mm	Malleable	AISI 410	Satin	1
18	1067-18	Malleable ribbon retractor 2 × 13"	50 × 330 mm	Malleable	AISI 410	Satin	1
19	1067-19	Spare Balfour pivot screws set	5 mm thread	Spare Part	AISI 410	Satin	2
20	1067-20	Instrument storage tray	480 × 280 × 40 mm	Tray Type	AISI 410	Satin	1
TOTAL QUANTITY							22



Modular Abdominal Wall Retractor System (Frame + Blades) - (GBAI-1066)

Sr. #	Code	Instrument Description	Specification	Type	Steel Type	Finish	QTY
01	1066-01	Main crossbar frame with ratchet	22" (55 cm)	Straight Frame	AISI 410	Satin	1
02	1066-02	Secondary crossbar / extension bar	18" (45 cm)	Straight Extension	AISI 410	Satin	1
03	1066-03	Table post clamp (universal)	Universal 16 mm	Clamp Type	AISI 410	Mirror	2
04	1066-04	Articulating arm with quick-coupler	25 cm	Articulating Type	AISI 410	Satin	2
05	1066-05	Blade holder, straight quick-couple	12 cm	Straight Holder	AISI 410	Satin	2
06	1066-06	Blade holder, straight quick-couple	12 cm	Angled Holder	AISI 410	Satin	2
07	1066-07	Right-angle blade holder	13 cm	Right-Angle Holder	AISI 410	Mirror	1
08	1066-08	Swivel joint coupler	3 cm	Swivel Joint Type	AISI 410	Satin	2
09	1066-09	Long vertical post	35 cm	Straight Post	AISI 410	Satin	1
10	1066-10	Short vertical post	20 cm	Straight Post	AISI 410	Satin	1
11	1066-11	Lateral arm with rack	30 cm	Straight Arm	AISI 410	Mirror	2
12	1066-12	Segmented side rail adapter	20 cm	Side-Rail Adapter	AISI 410	Mirror	1
13	1066-13	Kidney-shaped deep retractor blade, small	30 x 40 mm	Curved Blade	AISI 410	Satin	1
14	1066-14	Kidney-shaped deep retractor blade, medium	40 x 60 mm	Curved Blade	AISI 410	Satin	1
15	1066-15	Kidney-shaped deep retractor blade, large	50 x 80 mm	Curved Blade	AISI 410	Satin	1
16	1066-16	Deaver blade narrow	25 x 100 mm	Curved Blade	AISI 420	Satin	1
17	1066-17	Deaver blade medium	30 x 150 mm	Curved Blade	AISI 410	Satin	1
18	1066-18	Deaver blade wide	40 x 180 mm	Curved Blade	AISI 410	Satin	1
19	1066-19	Richardson blade small	20 x 60 mm	Curved Blade	AISI 410	Satin	1
20	1066-20	Richardson blade medium	30 x 80 mm	Curved Blade	AISI 410	Satin	1
21	1066-21	Richardson blade large	40 x 100 mm	Curved Blade	AISI 410	Satin	1
22	1066-22	Malleable ribbon retractor 1"	25 x 300 mm	Malleable	AISI 410	Satin	1
23	1066-23	Malleable ribbon retractor 1½"	38 x 330 mm	Malleable	AISI 410	Satin	1
24	1066-24	Malleable ribbon retractor 2"	50 x 330 mm	Malleable	AISI 410	Satin	1

Modular Abdominal Wall Retractor System (Frame + Blades) - (GBAI-1066)

Sr. #	Code	Instrument Description	Specification	Type	Steel Type	Finish	QTY
25	1066-25	Paddle/fenestrated blade narrow	25 × 70 mm	Flat Paddle Type	AISI 410	Satin	1
26	1066-26	Paddle/fenestrated blade wide	40 × 100 mm	Flat Paddle Type	AISI 410	Satin	1
27	1066-27	Bladder/viscera blade	50 × 150 mm	Curved Blade	AISI 410	Satin	1
28	1066-28	Chevron thoracoabdominal blade	70 × 180 mm	Angled Blade	AISI 410	Satin	1
29	1066-29	Instrument storage tray with silicone mat	480 × 280 × 40 mm	Tray Type	AISI 410	Satin	1
						TOTAL QUANTITY	35

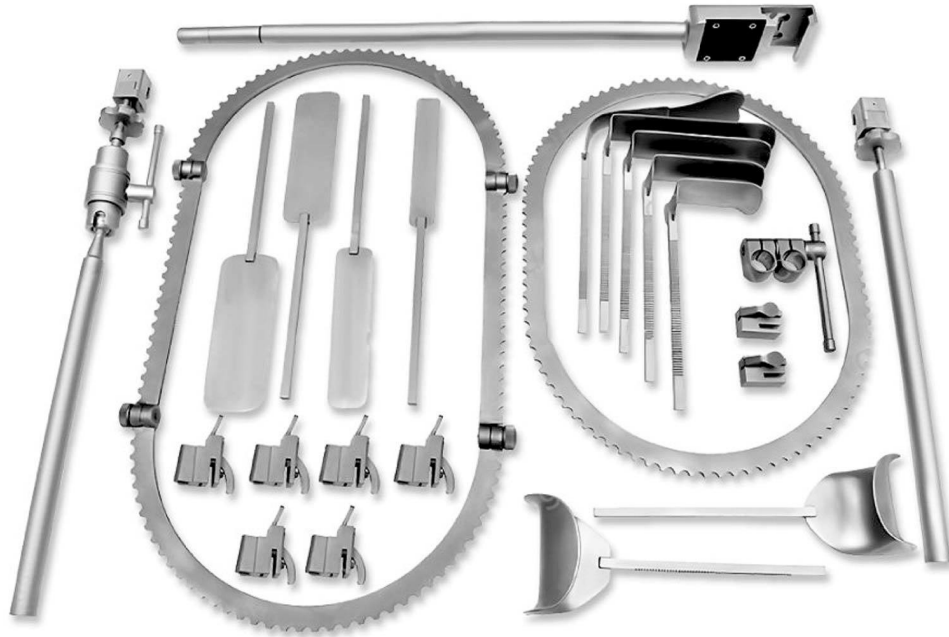

Circular Ring (Bookwalter-type) Retractor System - (GBAi-1068)

Sr. #	Code	Instrument Description	Specification	Type	Steel Type	Finish	QTY
01	1068-01	Round ring 16"	40 cm	Circular Ring	AISI 410	Satin	1
02	1068-02	Round ring 18"	45 cm	Circular Ring	AISI 410	Satin	1
03	1068-03	Oval ring	18" x 12"	Oval Ring	AISI 410	Satin	1
04	1068-04	Table post clamp, heavy-duty	25 cm	Clamp Type	AISI 410	Satin	2
05	1068-05	Vertical post, long	35 cm	Straight Post	AISI 410	Satin	1
06	1068-06	Vertical post, short	20 cm	Straight Post	AISI 410	Satin	1
07	1068-07	Rail clamp / side-rail adapter	20 cm	Clamp Adapter	AISI 410	Satin	2
08	1068-08	Floating joint coupler	3 cm	Swivel Type	AISI 410	Satin	2
09	1068-09	Blade holder, straight	12 cm	Straight Holder	AISI 410	Satin	2
10	1068-10	Blade holder, angled	12 cm	Angled Holder	AISI 410	Satin	2
11	1068-11	Right-angle blade holder	13 cm	Right-Angle Holder	AISI 410	Satin	1
12	1068-12	Long blade rack with ratchet	25 cm	Rack Type	AISI 410	Satin	1
13	1068-13	Short blade rack with ratchet	15 cm	Rack Type	AISI 410	Satin	1
14	1068-14	Bowel/viscera blade	40 x 120 mm	Curved Blade	AISI 410	Satin	1
15	1068-15	Fan blade small	30 x 60 mm	Fan Type	AISI 410	Satin	1
16	1068-16	Fan blade large	50 x 100 mm	Fan Type	AISI 420	Satin	1
17	1068-17	Kidney-shaped deep blade small	30 x 50 mm	Curved Blade	AISI 410	Satin	1
18	1068-18	Kidney-shaped deep blade medium	40 x 70 mm	Curved Blade	AISI 410	Satin	1
19	1068-19	Kidney-shaped deep blade large	50 x 90 mm	Curved Blade	AISI 410	Satin	1
20	1068-20	Deaver blade narrow	25 x 150 mm	Curved Blade	AISI 410	Satin	1
21	1068-21	Deaver blade medium	35 x 200 mm	Curved Blade	AISI 410	Satin	1
22	1068-22	Richardson blade medium	35 x 80 mm	Curved Blade	AISI 410	Satin	1
23	1068-23	Malleable ribbon 1"	25 x 300 mm	Malleable	AISI 410	Satin	1
24	1068-24	Malleable ribbon 1½"	38 x 330 mm	Malleable	AISI 410	Satin	1
25	1068-25	Smoke-evac / light clip bracket	8 mm port	Attachment Type	AISI 410	Satin	1
26	1068-26	Torque wrench for joints	13 cm	Tool Type	AISI 410	Satin	1
27	1068-27	Instrument storage tray with silicone mat	480 x 280 x 40 mm	Tray Type	AISI 410	Satin	1
TOTAL QUANTITY							32

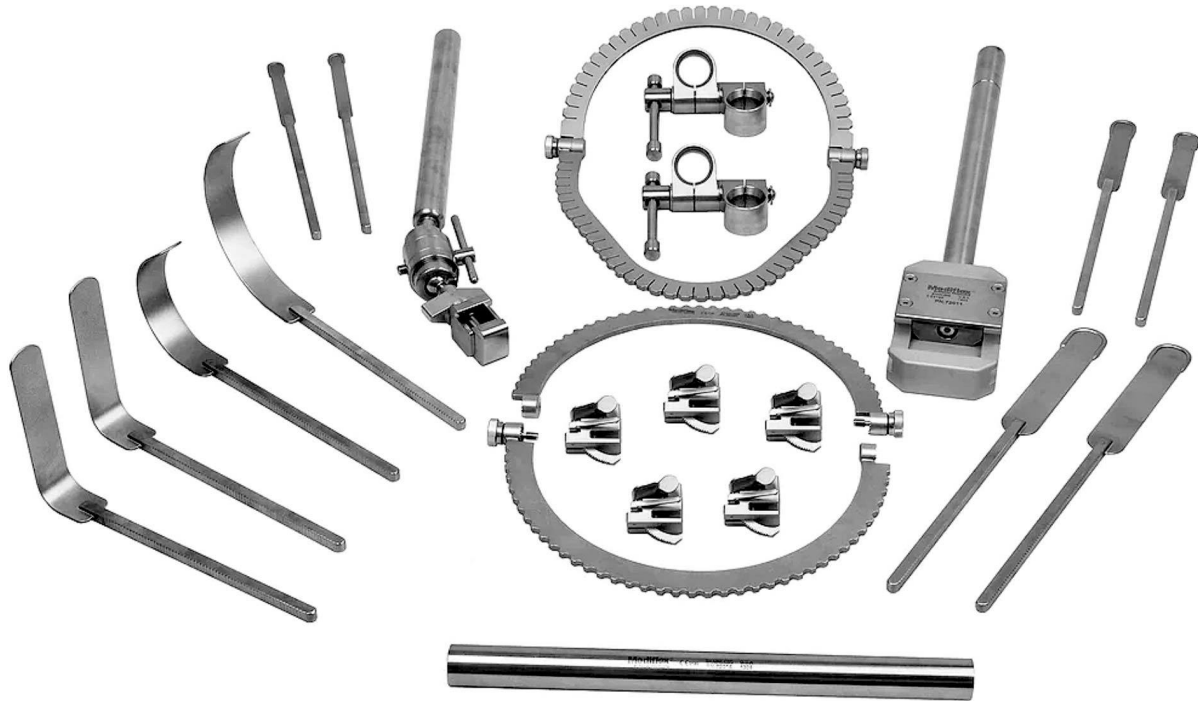

BOOKWALTER RETRATOR SET - (GBAI-1070)

Sr. #	Code	Instrument Description	Specification	Type	Steel Type	Finish	QTY
01	1070-01	Table mounting post	25 cm post	Post Type	AISI 410	Satin	1
02	1070-02	Bookwalter crossbar (long)	45 cm length	Straight Crossbar	AISI 410	Satin	1
03	1070-03	Bookwalter crossbar (short)	25 cm length	Short Crossbar	AISI 410	Satin	1
04	1070-04	Ring frame 12" diameter	Ø 300 mm	Ring Type	AISI 410	Satin	1
05	1070-05	Ring frame 8" diameter	Ø 200 mm	Ring Type	AISI 410	Satin	1
06	1070-06	Center post with gear joint	30 cm	Gear Post	AISI 410	Satin	1
07	1070-07	Blade holder, standard	12 cm	Standard Holder	AISI 410	Satin	2
08	1070-08	Blade holder, ball-socket type	12 cm	Ball-Socket Holder	AISI 410	Satin	2
09	1070-09	Blade holder, flexible arm type	25 cm	Flexible Holder	AISI 410	Satin	2
10	1070-10	Retractor blade, malleable 2" x 3"	2" x 3"	Malleable Blade	AISI 410	Satin	1
11	1070-11	Retractor blade, malleable 3" x 4"	3" x 4"	Malleable Blade	AISI 410	Satin	1
12	1070-12	Retractor blade, deep 4" x 6"	4" x 6"	Deep Blade	AISI 410	Satin	1
13	1070-13	Retractor blade, deep 6" x 8"	6" x 8"	Deep Blade	AISI 410	Satin	1
14	1070-14	Bowel blade 2½" x 6"	2½" x 6"	Curved Blade	AISI 410	Satin	1
15	1070-15	Bladder blade 2" x 5"	2" x 5"	Curved Blade	AISI 410	Satin	1
16	1070-16	Deaver blade 1½" x 12"	1½" x 12"	Curved Blade	AISI 410	Satin	1
17	1070-17	Deaver blade 2" x 12"	2" x 12"	Curved Blade	AISI 410	Satin	1
18	1070-18	Deaver blade 3" x 12"	3" x 12"	Curved Blade	AISI 410	Satin	1
19	1070-19	Malleable ribbon retractor 1" x 13"	1" x 13"	Malleable Ribbon	AISI 410	Satin	1
20	1070-20	Malleable ribbon retractor 2" x 13"	2" x 13"	Malleable Ribbon	AISI 410	Satin	1
21	1070-21	Vascular (aortic) blade 3" x 6"	3" x 6"	Curved Blade	AISI 410	Satin	1
22	1070-22	Balfour-type center blade 2" x 3"	2" x 3"	Curved Blade	AISI 410	Satin	1
23	1070-23	Clamp knob set (locking screws)	Set of 4	Accessory	AISI 410	Satin	4
24	1070-24	Ball-joint wrench	13 cm	Tool	AISI 410	Satin	1
25	1070-25	Instrument tray with silicone mat	480 x 280 x 40 mm	Tray Type	AISI 410	Satin	1
TOTAL QUANTITY							31



Basic Plastic Surgery Instrument Set-(GBAI-1011)

Sr. #	Code	Instrument Description	Specification	Type	Steel Type	Finish	QTY
01	GBAI1011-01	Allis Tissue 4 x 5 Teeth	15 cm	-	AISI 420A / 420B	Mirror Polish	2
02	GBAI1011-02	Gemini Mixer Delicate Full Jaws	14 cm	Curved	AISI 420 / 410	Mirror Polish	2
03	GBAI1011-03	Joseph Double Prong Skin Hook	15 cm x 2 mm	-	AISI 420 / 410	Mirror Polish	2
04	GBAI1011-04	Ferguson Frazier Suction Tube	9 FR	-	AISI 304 / 316L	Mirror Polish	1
05	GBAI1011-05	Joseph Hook Sharp Single Prong	17 cm	-	AISI 410 / 420	Satin Finish	2
06	GBAI1011-06	Weitlaner Retractor Blunt 3 x 4 Teeth	16 cm	-	AISI 410 / 420	Satin Finish	1
07	GBAI1011-07	Buck Ear Curette Straight, Sharp	9 FR	-	AISI 420 / 440A	Mirror Polish	1
08	GBAI1011-08	Jansen Mastoid Retractor 3x3 teeth Blunt	8 cm	-	AISI 420 / 440A	Satin Finish	1
09	GBAI1011-09	Senn Miller Retractor Sharp 3 Prong	16 cm	-	AISI 420 / 440A	Satin Finish	2
10	GBAI1011-10	TC Crilewood Needle Holder Smooth	15 cm	-	AISI 410 + Tungsten Carbide	Satin Finish (TC Jaws)	1
11	GBAI1011-11	Buck Ear Curette Straight, Sharp	24 cm	Curved	AISI 410 + Tungsten Carbide	Satin Finish (TC Jaws)	1
12	GBAI1011-12	Buck Ear Curette Straight, Blunt	12 cm	-	AISI 420 / 440A	Satin Finish	1
13	GBAI1011-13	Backhaus Towel Clamp	13 cm	-	AISI 410 / 420	Mirror Polish	8
14	GBAI1011-14	Iris Scissors Straight Sharp Tips	11 cm	Straight	AISI 410 / 420	Mirror Polish	1
15	GBAI1011-15	Hartmann Alligator Ear Forceps	14 cm	Curved	AISI 410 / 420	Mirror Polish	1
16	GBAI1011-16	Hartmann Forceps, Round Cup	16 cm	Curved	AISI 410 / 420	Satin Finish	1
17	GBAI1011-17	Halstead Mosquito Forceps	12 cm	Curved	AISI 420 / 420J2	Mirror Polish	2
18	GBAI1011-18	Halstead Mosquito Forceps	12 cm	Curved	AISI 420 / 420J2	Mirror Polish	2
19	GBAI1011-19	Lucae Bayonet Forceps	12 cm	-	AISI 420 / 440A	Satin Finish	1
20	GBAI1011-20	Micro Alligator Ear Forceps Cup Type	12 cm	-	AISI 420A	Satin Finish	1
21	GBAI1011-21	Adson Tissue Forceps 1x2 Teeth	12 cm	-	AISI 420 / 440A	Mirror Polish	1
22	GBAI1011-22	Adson Tissue Forceps 1x7 Teeth	12.5 cm	Curved	AISI 420 / 440A	Mirror Polish	1
23	GBAI1011-23	Iris Scissors Curved Sharp Tips	11 cm	Curved	AISI 420 / 420J2	Mirror Polish	1
24	GBAI1011-24	Ragnell Dissecting Scissors	12 cm	Straight	AISI 420 / 420J2	Mirror Polish	1
						Total Quantity	38



HAND SURGERY INSTRUMENT SET - 1065

Sr. #	Code	Instrument Description	Specification	Type	Steel Type	Finish	QTY
01	1065-01	Scalpel Handle No. 3	14 cm	Straight	AISI 410	Satin	1
02	1065-02	Scalpel Handle No. 7	15 cm	Straight	AISI 410	Satin	1
03	1065-03	Iris Scissors	11.5 cm	Curved	AISI 420	Mirror	1
04	1065-04	Metzenbaum Scissors Delicate	14 cm	Curved	AISI 420	Satin	1
05	1065-05	Adson Tissue Forceps 1x2 Teeth	12 cm	Straight	AISI 420	Satin	1
06	1065-06	Adson Brown Tissue Forceps 9x9 Teeth	12 cm	Straight	AISI 420	Satin	1
07	1065-07	Castroviejo Needle Holder	15 cm	Straight	AISI 420	Mirror	1
08	1065-08	Mayo Hegar Needle Holder	16 cm x 15 mm	Straight	AISI 420	Satin	1
09	1065-09	Hohmann Retractor Small	16 cm	Straight	AISI 420	Satin	2
10	1065-10	Senn Retractor Sharp Double Ended	15 cm	Straight	AISI 410	Satin	1
11	1065-11	Joseph Skin Hook Single Prong	15 cm	Double Ended Sharp	AISI 410	Mirror	1
12	1065-12	Joseph Skin Hook Single Prong	12.8 cm	Single Prong	AISI 410	Mirror	1
13	1065-13	Halsted Mosquito Forceps	18 cm	Double Prong	AISI 420	Satin	4
14	1065-14	Periosteal Elevator Molt 9	18 cm x 5 mm	Curved	AISI 420	Satin	1
15	1065-15	Freer Elevator	17 cm x 3 mm	Straight	AISI 420	Satin	1
16	1065-16	Bone Curette Cup	17 cm x 4 mm	Sharp/Blunt	AISI 420	Satin	2
17	1065-17	Osteotome	17 cm x 6 mm	Straight	AISI 420	Satin	1
18	1065-18	Osteotome	17 cm x 8 mm	Straight	AISI 420	Satin	1
19	1065-19	Osteotome	17 cm x 4 mm	Curved	AISI 420	Satin	1
20	1065-20	Gouge	17 cm x 6 mm	Straight	AISI 420	Satin	1
21	1065-21	Gouge	17 cm x 3 mm	Straight	AISI 420	Satin	1
22	1065-22	Langenbeck Retractor	6 x 15 mm	Retractor	AISI 410	Satin	1
23	1065-23	Langenbeck Retractor	8 x 20 mm	Retractor	AISI 410	Satin	1
24	1065-24	Langenbeck Retractor	10 x 25 mm	Retractor	AISI 410	Satin	1

HAND SURGERY INSTRUMENT SET - 1065

Sr. #	Code	Instrument Description	Specification	Type	Steel Type	Finish	QTY
25	1065-25	Self Retaining Retractor Adjustable	7 cm	Adjustable Self-Retaining	AISI 410	Satin	1
26	1065-26	Wire Cutter TC	14 cm	Angled TC	AISI 420	Satin	1
27	1065-27	Needle Holder TC	12.5 cm	Straight TC	AISI 420	Satin	1
28	1065-28	Needle Holder TC	14 cm	Straight TC	AISI 420	Mirror	1
29	1065-29	Stevens Tenotomy Scissors Straight	11 cm	Straight	AISI 420	Mirror	1
30	1065-30	Stevens Tenotomy Scissors Curved	11 cm	Curved	AISI 420	Satin	1
31	1065-31	Mayo Dissecting Scissors	14 cm	Straight	AISI 420	Satin	1
32	1065-32	Metzenbaum Dissecting Scissors	18 cm	Curved	AISI 420	Satin	1
33	1065-33	Babcock Intestinal Forceps	18 cm	Straight	AISI 420	Satin	1
34	1065-34	Rasp Fine-Coarse Dual Side	17 cm	Dual-Sided Rasp	AISI 410	Satin	1
35	1065-35	Mallet Small	300 g / 15 cm	Round Head	AISI 410	Satin	1
36	1065-36	Bone Holding Forceps	20 cm	Serrated	AISI 410	Satin	1
37	1065-37	Reduction Forceps	18 cm	Serrated	AISI 410	Satin	1
38	1065-38	Reduction Forceps	22 cm x 20 mm	Pointed	AISI 410	Satin	1
39	1065-39	Hohmann Retractor Medium	17 cm	Medium	AISI 410	Satin	1
40	1065-40	Elevator Double Ended	-----	Double Ended	AISI 410	Satin	1
41	1065-41	K Wire Driver Manual	18 cm	Manual	AISI 410	Satin	1
42	1065-42	Wire Passer	----	Angled	AISI 410	Satin	1
43	1065-43	Bone Drill	-----	Manual	AISI 420	Satin	1
44	1065-44	Raspatory Handle with Blades	10.5 cm	With Interchangeable Blades	AISI 420	Satin	1
45	1065-45	Osteotome Guard	14 cm	Protective Guard	AISI 420	Satin	1
46	1065-46	Suction Cannula	14 cm	Fine Tip Straight	AISI 420	Satin	1
47	1065-47	Bipolar Forceps	14 cm	Bayonet	AISI 420	Mirror	1
48	1065-48	Microvascular Scissors	14 cm	Angled	AISI 420	Mirror	1
49	1065-49	Microvascular Scissors	16 cm x 0.15 mm	Straight	AISI 410	Mirror	1
50	1065-50	Microvascular Scissors	16 cm x 0.3 mm	Curved	AISI 420	Mirror	1
51	1065-51	Micro Needle Holder TC	13 cm	Straight TC	AISI 420	Mirror	1
52	1065-52	Micro Needle Holder TC	13 cm	Curved TC	AISI 420	Mirror	1
53	1065-53	Micro Forceps	5.7 cm	Straight	AISI 420	Mirror	1
54	1065-54	Micro Forceps	0.8 - 2.0 mm	Straight	AISI 420	Mirror	1
55	1065-55	Micro Clip Applie	12 cm	Straight	AISI 420	Mirror	1
56	1065-56	Micro Clip Applie	12 cm	Straight	AISI 420	Mirror	1
57	1065-57	Bulldog Clamp	12 cm	Curved	AISI 420	Satin	1
58	1065-58	Vessel Dilator Set	16 cm	Angled	AISI 440A	Satin	1
59	1065-59	Vessel Hook	15 cm	Curved	AISI 420	Satin	1
60	1065-60	Vessel Hook	15 cm	Set	AISI 420	Satin	1
61	1065-61	Vessel Hook	12 cm	Double Fork	AISI 420	Satin	1
62	1065-62	Tendon Forceps	13 cm	Serrated	AISI 420	Satin	1
63	1065-63	Tendon Dissector Left	21.5 cm	Angled Left	AISI 420	Satin	1
64	1065-64	Tendon Dissector Right	15 cm	Angled Right	AISI 420	Satin	1
65	1065-65	Tendon Holder	Ø 5.5 mm	Round Holder	AISI 420	Satin	1
66	1065-66	Tendon Holder	Ø 7.5 mm	Round Holder	AISI 420	Satin	1
67	1065-67	Probe with Eye	13 cm	Straight	AISI 420	Satin	1
68	1065-68	Retractor Skin Hooklet Single	12 cm	Single Hooklet	AISI 420	Satin	1

HAND SURGERY INSTRUMENT SET - 1065

Sr. #	Code	Instrument Description	Specification	Type	Steel Type	Finish	QTY
69	1065-69	Retractor Skin Hooklet Double	12 cm	Double Hooklet	AISI 420	Satin	1
70	1065-70	Langenbeck Retractor	10 x 25 mm	Retractor	AISI 420	Satin	1
71	1065-71	Langenbeck Retractor	6 x 15 mm	Retractor	AISI 420	Satin	1
72	1065-72	Self Retaining Retractor	7 cm	Ratchet Type Self-Retaining	AISI 420	Satin	1
73	1065-73	Instrument Tray with Silicone Mat	-----	Tray Type	AISI 420	Satin	1
						TOTAL QUANTITY	79



Plastic & Reconstructive Surgery Set (GBAI-1073)

Sr. #	Code	Instrument Description	Specification	Type	Steel Type	Finish	QTY
01	1073-01	Iris Scissors	11 cm	Curved	AISI 420	Mirror	1
02	1073-02	Stevens Tenotomy Scissors	11 cm	Straight	AISI 420	Mirror	1
03	1073-03	Adson Tissue Forceps	12 cm, 1×2 teeth	Straight	AISI 410	Satin	2
04	1073-04	Bishop-Harmon Forceps	10 cm	Straight	AISI 410	Satin	1
05	1073-05	Skin Hook, single	6 cm	Straight	AISI 410	Satin	2
06	1073-06	Skin Hook, double	6 cm	Straight	AISI 410	Satin	2
07	1073-07	Senn Retractor	16 cm	Double Ended	AISI 410	Satin	1
08	1073-08	Scalpel Handle	No. 3	Straight	AISI 410	Satin	1
09	1073-09	Scalpel Handle	No. 3	Straight	AISI 410	Satin	1
10	1073-10	Needle Holder, Webster TC	13 cm	Straight	AISI 410 + TC (Tungsten Carbide)	Satin	1
11	1073-11	Fine Dissecting Scissors	12 cm	Curved	AISI 420	Mirror	1
12	1073-12	Fine Mosquito Forceps	12.5 cm	Straight	AISI 410	Satin	2
						TOTAL QUANTITY	16



Littauer Suture Removal Scissors(**GBAI-1033**)

Sr. #	Code	Instrument Description	Specification	Type	Steel Type	Finish	QTY
01	GBAI1033-01	Tray (Stainless Steel)	20 × 10 × 3 cm	-	AISI 304	Mirror	1
02	GBAI1033-02	Littauer Scissors (Hook-Tipped)	11.5 cm (4½")	Curved	AISI 420	Satin	1
03	GBAI1033-03	Gauze Sponge	7.5 × 7.5 cm (3" × 3")	-	Cotton	Non-Metallic	1
04	GBAI1033-04	Metal Forceps	10 cm (4")	Straight	AISI 410	Satin	1
						TOTAL QUANTITY	4



Surgical Extraction Kit-(GBAI-1045)

Sr. #	Code	Instrument Description	Specification	Type	Steel Type	Finish	QTY
01	GBAI1045-01	Upper Incisors, Cuspids & Bicuspids Extraction Forceps	15 cm (6")	Straight	AISI 420	Mirror	1
02	GBAI1045-02	Lower Incisors, Cuspids & Bicuspids Extraction Forceps	15 cm (6")	Straight	AISI 420	Mirror	1
03	GBAI1045-03	Upper Premolar, Wisdom & Roots Extraction Forceps (Mead #1)	16 cm (6.3")	Curved	AISI 420	Mirror	1
04	GBAI1045-04	Upper Molars Extraction Forceps (Mead #2)	16 cm (6.3")	Curved	AISI 420	Mirror	1
05	GBAI1045-05	Lower Molars Extraction Forceps (Mead #2)	15 cm (6")	Straight	AISI 420	Mirror	1
06	GBAI1045-06	Lower Molars Extraction Forceps (Mead #3)	15 cm (6")	Curved	AISI 420	Mirror	1
07	GBAI1045-07	Lower Molar "Cow Horn" Extraction Forceps (#23)	17 cm (6.7")	Curved	AISI 420	Mirror	1
08	GBAI1045-08	Extraction Forceps (#286)	15 cm (6")	Straight	AISI 420	Mirror	1
09	GBAI1045-09	Crown Remover Gripper (Angled with Silicone Tips)	13 cm (5.1")	Angled	AISI 410 + Silicone Tip	Satin	1
10	GBAI1045-10	Heidbrink Root Tip Pick Elevator (Right)	14 cm (5.5")	Angled Right	AISI 420	Mirror	1
11	GBAI1045-11	Heidbrink Root Tip Pick Elevator (Left)	14 cm (5.5")	Angled Left	AISI 420	Mirror	1
12	GBAI1045-12	Heidbrink Root Tip Pick Elevator (Left)	14 cm (5.5")	Straight	AISI 420	Mirror	1
13	GBAI1045-13	Heidbrink Root Tip Pick Elevator (Straight)	14 cm (5.5")	Straight	AISI 420	Mirror	1
14	GBAI1045-14	Root Elevator (301 Pattern)	14 cm (5.5")	Curved	AISI 410	Mirror	1
15	GBAI1045-15	Root Elevator (302 Pattern)	14 cm (5.5")	Curved	AISI 420	Mirror	1
16	GBAI1045-16	Root Elevator (303 Pattern)	14 cm (5.5")	Curved Right	AISI 420	Mirror	1
17	GBAI1045-17	Root Elevator 77R Pattern)	12 cm (4.75")	Straight	AISI 420	Mirror	1
18	GBAI1045-18	Foerster Sponge Forceps (Serrated Jaws)	12 cm (4.75")	Straight	AISI 420	Satin	1
19	GBAI1045-19	Lindo-Levien Elevator (Right, Serrated)	15 cm (6")	Curved	AISI 420	Satin	1
20	GBAI1045-20	Lindo-Levien Elevator (Left, Serrated)	15 cm (6")	Angled Right	AISI 420	Satin	1
21	GBAI1045-21	Iris Scissors	11.5 cm (4.5")	Angled Left	AISI 420	Mirror	1
22	GBAI1045-22	Iris Scissors	11.5 cm (4.5")	Straight	AISI 420	Mirror	1
23	GBAI1045-23	Mosquito Hemostatic Forceps	12.5 cm (5")	Angled	AISI 410	Satin	1
24	GBAI1045-24	Crane Elevator (Right)	15 cm (6")	Curved	AISI 420	Satin	1

Surgical Extraction Kit-(GBAI-1045)

Sr. #	Code	Instrument Description	Specification	Type	Steel Type	Finish	QTY
25	GBAI1045-25	Crane Elevator (Left)	15 cm (6")	Angled Left	AISI 420	Satin	1
26	GBAI1045-26	Crile-Wood Needle Holder	15 cm (6")	Straight	AISI 410	Satin	1
27	GBAI1045-27	Periosteal Elevator (Molt M9)	17 cm (6.7")	Curved	AISI 420	Mirror	1
28	GBAI1045-28	Dental Mirror (#5)	Standard	Round Type	AISI 304	Satin	1
29	GBAI1045-29	Periosteal Elevator (Seldin S23)	17 cm (6.7")	Curved	AISI 420	Mirror	1
30	GBAI1045-30	College Cotton Plier	16 cm (6.3")	Angled	AISI 410	Satin	1
31	GBAI1045-31	Minnesota Cheek Retractor	14 cm (5.5")	Curved	AISI 420	Satin	1
32	GBAI1045-32	Dental Explorer Probe (#5)	17 cm (6.7")	Double End	AISI 420	Satin	1
33	GBAI1045-33	Dental Syringe (Aspirating, 18 cc)	-----	-	AISI 410	Satin	1
34	GBAI1045-34	Scalpel Handle (#3)	14 cm (5.5")	Straight	AISI 410	Mirror	1
35	GBAI1045-35	Scalpel Handle (#4)	14 cm (5.5")	Straight	AISI 304	Mirror	1
36	GBAI1045-36	Scalpel Blades (#10, fits #3 Handle)	-----	-----	AISI 304	Mirror	25
37	GBAI1045-37	Scalpel Blades (#20, fits #4 Handle)	-----	-----	AISI 420	Mirror	25
						TOTAL QUANTITY	85



Surgical Suture Removal Kit-(GBAI-1046)

Sr. #	Code	Instrument Description	Specification	Type	Steel Type	Finish	QTY
01	GBAI1046-01	Dissecting Forceps, Iris, Toothed	10 cm	Straight	AISI 410	Satin	1
02	GBAI1046-02	Kidney Dish Receiver, Polypropylene	20 cm	Curved / Bowl Type	Polypropylene	Matte	1
03	GBAI1046-03	Scissors, Iris	10.5 cm	Straight	AISI 420	Mirror	1
04	GBAI1046-04	Sterile Field	60 x 60 cm	Sheet	Nonwoven Fabric (SMS / PP)	Sterile (EO)	1
05	GBAI1046-05	Hand Towel	45 x 45 cm	Cloth / Folded	Nonwoven Viscose Blend	Sterile	1
06	GBAI1046-06	Nonwoven Swabs, 4-Ply	10 x 10 cm	Pad Type	Viscose / Polyester Blend	Sterile	4
07	GBAI1046-07	Disposable Clinical Waste Bag with Tape	Standard	Bag Type	HDPE	Non-Sterile	1
						TOTAL QUANTITY	10



Suture Removal Set-(GBAI-1047)

Sr. #	Code	Instrument Description	Specification	Type	Steel Type	Finish	QTY
01	GBAI1047-01	Polypropylene Forceps	12.5 cm	Straight	Medical-Grade Polypropylene (PP)	-----	1
02	GBAI1047-02	Softsorb Swabs	7.5 × 7.5 cm (4-Ply)	Pad Type	Non-Woven Viscose/Polyester Blend	-----	2
03	GBAI1047-03	Clinical Waste Bag	Standard Size	Bag Type	HDPE (High-Density Polyethylene) – Biohazard Yellow	-----	1
04	GBAI1047-04	Stitch Cutter (Disposable)	12 cm	Straight / Fine Edge	Stainless Steel AISI 420 Blade with Polypropylene Handle	Mirror-Finished Blade / Sterile	1
TOTAL QUANTITY							5



Military Suture Kit-(GBAI-1036)

Sr. #	Code	Instrument Description	Specification	Type	Steel Type	Finish	QTY
01	GBAI1036-01	Hemostat (Straight)	14 cm (5½")	Straight	AISI 410	SATIN	2
02	GBAI1036-02	Hemostat (Curved)	14 cm (5½")	Curved	AISI 410	SATIN	1
03	GBAI1036-03	Tweezers (Dressing / Dissecting Forceps)	12.5 cm (5")	Straight	AISI 420	SATIN	1
04	GBAI1036-04	Scalpel Handle No. 3	13 cm	Straight	AISI 420	SATIN	1
05	GBAI1036-05	Scissors (Operating Type)	14 cm (5½")	Straight	AISI 410	SATIN	1
06	GBAI1036-06	Needle Holder (Mayo-Hegar Type)	14 cm (5½")	Straight	AISI 410	SATIN	2
07	GBAI1036-07	Suture Set (Sterile Pack)	-----	-	AISI 410	-----	1
08	GBAI1036-08	Needle Probe	15 cm	Straight	----	-----	1
09	GBAI1036-09	Alcohol Wipes (Sterile)	Standard 6 × 6 cm	-	AISI 304	-----	2
10	GBAI1036-10	Antiseptic BZK Wipes	Standard 6 × 6 cm	-	----	-----	2
11	GBAI1036-11	Pen Light	13 cm	Straight	----	-----	1
12	GBAI1036-12	Scalpel Blades (Sterile)	No. 10 & No. 11	-	----	-----	
						TOTAL QUANTITY	16



Laparoscopy Basic Instrument Set (GBAI-1071)

Sr. #	Code	Instrument Description	Specification	Type	Steel Type	Finish	QTY
01	1071-01	Laparoscopic Trocar Cannula	10 mm × 100 mm	Straight	AISI 420	Mirror	2
02	1071-02	Laparoscopic Trocar Cannula	5 mm × 100 mm	Straight	AISI 420	Mirror	2
03	1071-03	Laparoscopic Grasping Forceps	5 mm × 330 mm	Curved	AISI 420	Mirror	2
04	1071-04	Laparoscopic Scissors, insulated	5 mm × 330 mm	Curved	AISI 420	Mirror	1
05	1071-05	Laparoscopic Needle Holder	5 mm × 330 mm	Straight	AISI 420	Mirror	1
06	1071-06	Laparoscopic Dissector	5 mm × 330 mm	Curved	AISI 420	Mirror	1
07	1071-07	Laparoscopic Suction-Irrigation Cannula	5 mm × 330 mm	Straight	AISI 410	Satin	1
08	1071-08	Laparoscopic Hook Electrode	5 mm × 330 mm	Angled	AISI 410	Satin	1
09	1071-09	Veress Needle	120mm	Straight	AISI 420	Mirror	1
10	1071-10	Endoscopic Clip Applier	5 mm	Straight	AISI 410	Mirror	1
11	1071-11	Needle Probe	330 mm	Straight	AISI 410	Mirror	1
12	1071-12	Bipolar Forceps, reusable	5 mm	Curved	AISI 410	Satin	1
TOTAL QUANTITY							15

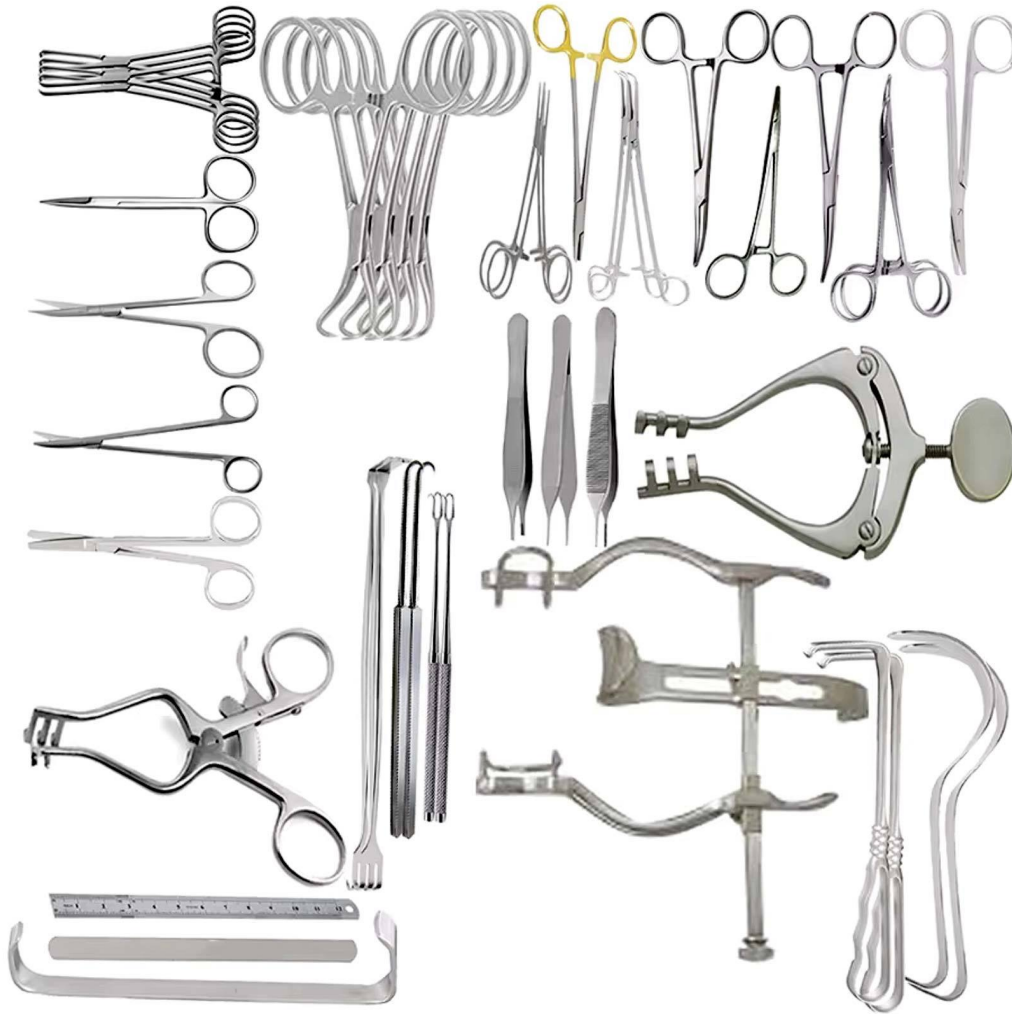

Pediatric Surgery Set (GBAI-1077)

Sr. #	Code	Instrument Description	Specification	Type	Steel Type	Finish	QTY
01	1077-01	Mosquito Forceps, Halsted	12.5 cm	Straight	AISI 410	Satin	4
02	1077-02	Mosquito Forceps, Halsted	12.5 cm	Curved	AISI 410	Satin	4
03	1077-03	Metzenbaum Scissors	14 cm	Curved	AISI 420	Mirror	1
04	1077-04	Needle Holder, Webster TC	13 cm	Straight	AISI 410 + TC (Tungsten Carbide)	Satin	1
05	1077-05	Forceps, Dressing	12 cm	Straight	AISI 410	Satin	1
06	1077-06	Forceps, Adson 1x2 teeth	12 cm	Straight	AISI 410	Satin	1
07	1077-07	Retractor, Army-Navy	Small	Straight	AISI 410	Satin	1
08	1077-08	Skin Hook mini	5 cm	Straight	AISI 410	Satin	2
09	1077-09	Suction Tube, pediatric	Ø 2 mm x 180 mm	Straight	AISI 410	Satin	1
10	1077-10	Scalpel Handle	No. 3	Straight	AISI 410	Satin	1
11	1077-11	Scalpel Handle	#15 (10 pcs)	Straight	AISI 420	Mirror	1
12	1077-12	Bowl & Kidney Tray Set	SS 180 mm	Straight	AISI 410	Mirror	1
						TOTAL QUANTITY	19



Veterinary Surgical Kit-(GBAI-1055)

Sr. #	Code	Instrument Description	Specification	Type	Steel Type	Finish	QTY
01	GBAI1055-01	Mayo Dissecting Scissors	15.5 cm (6")	Straight	AISI 420	Mirror	1
02	GBAI1055-02	Metzenbaum Dissecting Scissors	14.5 cm (5 ¾")	Curved	AISI 420	Mirror	1
03	GBAI1055-03	Halsted Mosquito Artery Forceps	12.5 cm (5")	Curved	AISI 410	Satin	1
04	GBAI1055-04	Olsen-Hegar Needle Holder w/ Built-in Scissors	14 cm (5 ½")	Straight	AISI 410 + TC (Tungsten Carbide)	Satin	1
05	GBAI1055-05	Halsted Mosquito Artery Forceps	12.5 cm (5")	Curved	AISI 410	Satin	2
06	GBAI1055-06	Kelly Hemostatic Forceps	14 cm (5 ½")	Curved	AISI 410	Satin	2
07	GBAI1055-07	Rochester Carmalt Hemostatic Forceps	16 cm (6 ¼")	Curved	AISI 410	Satin	2
08	GBAI1055-08	Adson-Brown Tissue Forceps	12 cm (4 ¾")	Straight	AISI 410	Satin	1
09	GBAI1055-09	Scalpel Handle #3	14 cm (5 ½")	Straight	AISI 410	Satin	2
10	GBAI1055-10	Spay Hook (Probe Ended)	13.5 cm (5 ¾")	Curved Hook Tip	AISI 410	Satin	2
11	GBAI1055-11	Backhaus Towel Clamp	11 cm (4 ¼")	Curved	AISI 410	Satin	4
						TOTAL QUANTITY	19



Post-mortem Instrument Set-(GBAI-1042)

Sr. #	Code	Instrument Description	Specification	Type	Steel Type	Finish	QTY
01	GBAI1042-01	Scalpel with Metal Handle (Cutting Length 37 mm)	14 cm Handle / 3.7 cm Blade	Straight	AISI 420	Mirror	1
02	GBAI1042-02	Cartilage Knife with Metal Handle (Cutting Length 55 mm)	18 cm Handle / 5.5 cm Blade	Straight	AISI 420	Mirror	1
03	GBAI1042-03	Virchow Autopsy Knife with Metal Handle	22 cm Handle / 8.5 cm Blade	Straight	AISI 420	Mirror	1
04	GBAI1042-04	Bone Shears	23 cm	Straight	AISI 420	Mirror	1
05	GBAI1042-05	Incision Scissors	14.5 cm	Straight	AISI 420	Satin	1
06	GBAI1042-06	Bowel Scissors	21 cm	Curved	AISI 420	Satin	1
07	GBAI1042-07	Bone Saw (Includes Spare Blade)	35 cm	Straight	AISI 420	Satin	1
08	GBAI1042-08	Dissecting Forceps	13 cm	Straight	AISI 410	Satin	2
09	GBAI1042-09	Metal Mallet (Bergmann Type, 300 g)	23.5 cm	Straight / Solid Head	AISI 410	Matte	1
10	GBAI1042-10	Rachiotom Knife	22 cm	Curved	AISI 420	Satin	2
11	GBAI1042-11	Osteotome	13 cm	Straight	AISI 420	Satin	2
12	GBAI1042-12	Retractors (Double Ended, 65 mm)	6.5 cm Blade / 18 cm Length	Double-Ended	AISI 420	Mirror	2
13	GBAI1042-13	Blow Pipe (Straight, Double)	10.4 cm	Straight / Double Type	AISI 410	Mirror	2
14	GBAI1042-14	Probes (145 mm / 2.0 mm Tip)	14.5 cm	Straight	AISI 420	Matte	2
15	GBAI1042-15	Surgical Needles (Assorted)	-----	Curved / Straight Mix	AISI 410	Mirror	12
16	GBAI1042-16	Folding Ruler	30 cm	Straight	AISI 304	Polished	1
17	GBAI1042-17	Measuring Glass	100 mL	Cylindrical	AISI 304	Transparent (Glass)	1
TOTAL QUANTITY							33



Bipolar Instrument Set-(GBAI-1012)

Sr. #	Code	Instrument Description	Specification	Type	Steel Type	Finish	QTY
01	GBAI1012-01	Rasp for bipolar prosthesis	-	-	AISI 420 / 440A	Mirror Polish	1
02	GBAI1012-02	Murphy Lane Bone Skid	-	-	AISI 420 / 440A	Mirror Polish	1
03	GBAI1012-03	Judet head extractor	-	-	AISI 410 / 420	Mirror Polish	1
04	GBAI1012-04	Moore's hollow chisel	-	-	AISI 420 / 440A	Mirror Polish	1
05	GBAI1012-05	RAM ROD	-	-	AISI 410 / 420	Mirror Polish	1
06	GBAI1012-06	Measuring gauge for prosthesis (37 to 55)	-	-	AISI 304 / 316L	Satin Finish	1
07	GBAI1012-07	RAM	-	-	AISI 410 / 440	Mirror Polish	1
08	GBAI1012-08	RAM ROD handle	-	-	AISI 410 / 440	Mirror Polish	1
09	GBAI1012-09	HooksTommy Bar	-	-	AISI 410 / 440	Mirror Polish	1
10	GBAI1012-10	Introducer for bipolar	-	-	AISI 410 / 440	Mirror Polish	1
11	GBAI1012-11	Tapered reamer for bipolar	-	-	AISI 410 / 440	Mirror Polish	1
12	GBAI1012-12	Bakes Dilator	-	-	AISI 410 / 440	Mirror Polish	1
13	GBAI1012-13	Instrument box with implant tray	-	-	AISI 304 / 316L	Matte Finish (Tray Interior)	1
						TOTAL QUANTITY	13



Arthroscopy Instrument Set-(GBAI-1006)

Sr. #	Code	Instrument Description	Specification	Type	Steel Type	Finish	QTY
01	ARTH-1001	Switching Stick	-	-	AISI 420 / 440A	Satin / Mirror Polish	1
02	ARTH-1002	Reusable Cannula Introducer	8MM	-	AISI 420 / 420A	Satin / Mirror Polish	1
03	ARTH-1003	Reusable Cannula Introducer	5.5MM	-	AISI 420 / 440A	Mirror Polish	1
04	ARTH-1004	Crochet Hook	-	-	AISI 420 / 440A	Satin Finish	1
05	ARTH-1005	Labral Probe	-	-	AISI 420 / 440A	Mirror Polish	1
06	ARTH-1006	Knot Pusher	-	-	AISI 420 / 440	Mirror Polish	1
07	ARTH-1007	Tissue Elevator - 15° up	-	-	AISI 420 / 440A	Satin Finish	1
08	ARTH-1008	Tissue Elevator - 15° down	-	-	AISI 420 / 440A	Satin Finish	1
09	ARTH-1009	Tissue Elevator - 30° down	-	-	AISI 420 / 440A	Mirror Polish	1
10	ARTH-1010	Ring Curette 5.4MM - Both Side	-	-	AISI 420 / 440A	Mirror Polish	1
11	ARTH-1011	Gienoid RPS-p - Up	-	-	AISI 420 / 440A	Mirror Polish	1
12	ARTH-1012	Gienoid RPS-p - down	-	-	AISI 420 / 440A	Mirror Polish	1
13	ARTH-1013	Reusable Suture PPS-ser 25°, Left	-	-	AISI 420 / 440A	Mirror Polish	1
14	ARTH-1014	Reusable Suture PPS-ser 25°, Right	-	-	AISI 420 / 440A	Satin Finish	1
15	ARTH-1015	Reusable Suture PPS-ser 45°, Left	-	-	AISI 420 / 440A	Satin Finish	1
16	ARTH-1016	Reusable Suture PPS-ser 45°, Right	-	-	AISI 420 / 440A	Mirror Polish	1
17	ARTH-1017	Reusable Suture PPS-ser 50°, Right	-	-	AISI 304 + Nitinol Wire	Mirror Polish	1
18	ARTH-1018	Nitinol Wire Loop for Reusable Suture PPS-ser	-	-	AISI 420 / 440A	Mirror Polish	1
19	ARTH-1019	Suture PPS-ser	-	-	AISI 420 / 440A	Mirror Polish	1
20	ARTH-1020	Suture Cutter	-	-	AISI 420 / 440A	Satin Finish	1
21	ARTH-1021	Blade for Suture PPS-ser	-	-	AISI 420 / 440A	Satin Finish	1
22	ARTH-1022	Birth Beak Left	-	-	AISI 420 / 440A	Satin Finish	1
23	ARTH-1023	Birth Beak Straight	-	-	AISI 420 / 440A	Satin Finish	1
24	ARTH-1024	Suture Retriever Straight	-	-	AISI 420 / 440A	Satin Finish	1

Arthroscopy Instrument Set-(GBAI-1006)

Sr. #	Code	Instrument Description	Specification	Type	Steel Type	Finish	QTY
25	ARTH-1025	Combination Teeth GrPS-per	-	-	AISI 420 / 440A	Mirror Polish	1
26	ARTH-1026	Retriever - Tissue GrPS-per	-	-	AISI 420 / 440A	Mirror Polish	1
27	ARTH-1027	Birth Beak Right	-	-	AISI 420 / 440A	Mirror Polish	1
28	ARTH-1028	Birth Beak Upward	-	-	AISI 420 / 440A	Satin Finish	1
29	ARTH-1029	GrPS-per Hook Jaw	-	-	AISI 420 / 440A	Mirror Polish	1
30	ARTH-1030	Fiber Tape Retriever	-	-	AISI 420 / 440A	Mirror Polish	1
31	ARTH-1031	Double Lumen Cannula, Up-Right	-	-	AISI 420 / 440A	Satin Finish	1
32	ARTH-1032	Double Lumen Cannula, Up-Left	-	CURVED	AISI 420 / 440A	Satin Finish	1
33	ARTH-1033	Double Lumen Cannula, Up- Straight	-	CURVED	AISI 420 / 440A	Satin Finish	4
34	ARTH-1034	Double Lumen Cannula, Left/Right	-	STRAIGHT	AISI 420 / 440A	Mirror Polish	1
35	ARTH-1035	Double Lumen Cannula, Up/Down	-	CURVED	AISI 420 / 440A	Mirror Polish	1
36	ARTH-1036	Posterior Access Cannula	-	CURVED	AISI 420 / 440A	Mirror Polish	1
37	ARTH-1037	Single Cannula (2 included with set)	-	-	AISI 420 / 440A	Mirror Polish	1
38	ARTH-1038	Cannula Bender	-	-	AISI 420 / 440A	Satin Finish	1
39	ARTH-1039	Tendon Stripper, Closed end, 6mm	-	-	AISI 420 / 440A	Satin Finish	1
40	ARTH-1040	Graphical CPS-e For Meniscal Repair Set	-	-	AISI 304 / 316L	Matte Finish (Sterile Set Tray)	1
						TOTAL QUANTITY	40

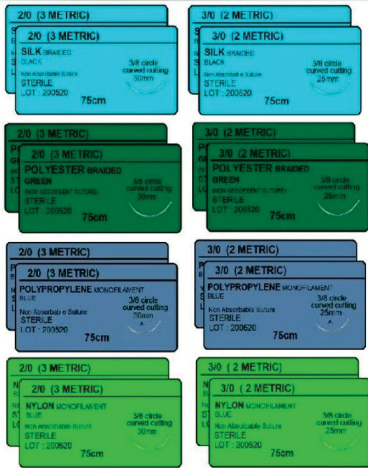

MEDICAL STUDENT PRACTICE SET 1 (GBAI - 1080)

Sr. #	Code	Instrument Description	Specification	Type	Steel Type	Finish	QTY
01	GBAI1080-01	Scalpel Handle No. 3	#3	Reusable	AISI 420 Satin	Satin	1
02	GBAI1080-02	Scalpel Handle No. 4	#4	Reusable	AISI 420 Satin	Satin	1
03	GBAI1080-03	Lister Bandage Scissor	14 CM	Reusable	AISI 420 Mirror	Mirror	1
04	GBAI1080-04	Dressing Scissor Sharp/Blunt	14 CM	Reusable	AISI 420 Mirror	Mirror	1
05	GBAI1080-05	Mosquito Forceps Straight	12.5 CM	Reusable	AISI 420 Satin	Satin	1
06	GBAI1080-06	Mosquito Forceps Curved	12.5 CM	Reusable	AISI 420 Satin	Satin	1
07	GBAI1080-07	Needle Holder	12.5 CM	Reusable	AISI 420 Satin	Satin	1
08	GBAI1080-08	Dressing Forceps	12 CM	Reusable	AISI 420 Satin	Satin	1
09	GBAI1080-09	Dressing Forceps Toothed 1x2	12 CM	Reusable	AISI 420 Satin	Satin	1
10	GBAI1080-10	Probe	-	Reusable	AISI 420 Satin	Satin	1
11	GBAI1080-11	Groove Director	-	Reusable	AISI 420 Satin	Satin	1
12	GBAI1080-12	Sutures	-	Consumable	N/A	N/A	1
13	GBAI1080-13	Case (Red Zipper Pouch)	-	PU/Cloth	Pouch	N/A	1
14	GBAI1080-14	Suture Pad	17x12 cm or custom	Medical-grade silicone + multi-layer fiber-mesh reinforced	N/A	Skin-tone matte	1
						TOTAL QTY	14



MEDICAL STUDENT PRACTICE SET 2 (GBAI - 1081)

Sr. #	Code	Instrument Description	Specification	Type	Steel Type	Finish	QTY	
01	GBAI1081-01	Scalpel Handle	#3	Reusable	AISI 420 Satin	Satin	1	
02	GBAI1081-02	Adson Forcep Non-Toothed	12 CM	Reusable	AISI 420 Satin	Satin	1	
03	GBAI1081-03	Iris Scissor Straight Round Pattern	10 CM	Reusable	AISI 420 Mirror	Mirror	1	
04	GBAI1081-04	Needle Holder	12.5 CM	Reusable	AISI 420 Satin	Satin	1	
05	GBAI1081-05	Mall Probe Seeker Straight	15 CM	Reusable	AISI 420 Satin	Satin	1	
06	GBAI1081-06	Groove Director	14 CM	Reusable	AISI 420 Satin	Satin	1	
07	GBAI1081-07	Dressing Scissor S/B Straight	14 CM	Reusable	AISI 420 Mirror	Mirror	1	
08	GBAI1081-08	Mall Probe Seeker Curved	15 CM	Reusable	AISI 420 Satin	Satin	2	
09	GBAI1081-09	Splinter Forcep	11 CM	Reusable	AISI 420 Satin	Satin	1	
10	GBAI1081-10	Tissue Forcep 1x2 Teeth	10 CM	Reusable	AISI 420 Satin	Satin	1	
11	GBAI1081-11	Zipper Case (Red Inner Cloth)	---	Pouch	N/A	N/A	1	
12	GBAI1081-12	Suture Pad	17x12 cm or custom	Medical-grade silicone + multi-layer fiber-mesh reinforced	N/A	Skin-tone matte	1	
							TOTAL QTY	13



MEDICAL STUDENT PRACTICE SET 3 (GBAI-1082)

Sr. #	Code	Instrument Description	Specification	Type	Steel Type	Finish	QTY
01	GBAI1082-01	Mosquito Forceps Curved	12.5 CM	Reusable	AISI 410 Satin	Satin	1
02	GBAI1082-02	Needle Holder	12.5 CM	Reusable	AISI 410 Satin	Satin	1
03	GBAI1082-03	Scalpel Handle #3	#3	Reusable	AISI 410 Satin	Satin	1
04	GBAI1082-04	Iris Scissor Straight	10 CM	Reusable	AISI 420 Mirror	Mirror	1
05	GBAI1082-05	Adson Forcep Toothed	12 CM	Reusable	AISI 410 Satin	Satin	1
06	GBAI1082-06	Case with Blue Inner Cloth	----	Reusable	N/A	N/A	1
TOTAL QTY							6



STUDENT MINI SET (GBAI - 1083)

Sr. #	Code	Instrument Description	Specification	Type	Steel Type	Finish	QTY
01	GBAI1083-01	Mosquito Forceps Curved	12.5 CM	Reusable	AISI 410 Satin	Satin	1
02	GBAI1083-02	Scalpel Handle #3	#4	Reusable	AISI 410 Satin	Satin	1
03	GBAI1083-03	Dressing Scissor Sharp/Blunt	14 CM	Reusable	AISI 410 Mirror	Mirror	1
						TOTAL QTY	3



DENTAL SET 1 (GBAI-1084)

Sr. #	Code	Instrument Description	Specification	Type	Steel Type	Finish	QTY
01	GBAI1084-01	Mosquito Forceps Straight	12.5 CM	Reusable	AISI 410 Satin	Satin	1
02	GBAI1084-02	Mosquito Forceps Curved	12.5 CM	Reusable	AISI 410 Satin	Satin	1
03	GBAI1084-03	Towel Forcep	14 CM	Reusable	AISI 410 Satin	Satin	1
04	GBAI1084-04	Needle Holder Mayo-Hegar	16 CM	Reusable	AISI 410 Satin	Satin	1
05	GBAI1084-05	Adson Forcep	12.5 CM	Reusable	AISI 410 Satin	Satin	1
06	GBAI1084-06	Scissor Straight S/S	14 CM	Reusable	AISI 420 Mirror	Mirror	1
07	GBAI1084-07	Scissor Curved S/S	14 CM	Reusable	AISI 420 Mirror	Mirror	1
08	GBAI1084-08	Mouth Mirror Handle + Mirror	#4 / Standard	Reusable	AISI 410 Satin	Satin	1
09	GBAI1084-09	Dental Explorer (Sickle)	-	Reusable	AISI 410 Satin	Satin	1
10	GBAI1084-10	Dental Explorer Double End	Pigtail/Probe	Reusable	AISI 410 Satin	Satin	1
11	GBAI1084-11	Periodontal Probe	-	Reusable	AISI 410 Satin	Satin	1
12	GBAI1084-12	Scaler Sickle Type	-	Reusable	AISI 410 Satin	Satin	1
13	GBAI1084-13	Scaler Straight	-	Reusable	AISI 410 Satin	Satin	1
14	GBAI1084-14	Scaler Curved	-	Reusable	AISI 410 Satin	Satin	1
15	GBAI1084-15	Scaler Posterior Type	-	Reusable	AISI 410 Satin	Satin	1
16	GBAI1084-16	Excavator Double End	-	Reusable	AISI 410 Satin	Satin	1
17	GBAI1084-17	Plugger/Condenser Double End	-	Reusable	AISI 410 Satin	Satin	1
18	GBAI1084-18	Carver Double End	-	Reusable	AISI 410 Satin	Satin	1
19	GBAI1084-19	Spatula Double End	-	Reusable	AISI 410 Satin	Satin	1
20	GBAI1084-20	Dental Hoe Double End	-	Reusable	AISI 410 Satin	Satin	1
21	GBAI1084-21	Root Elevator (Straight)	-	Reusable	AISI 410 Satin	Satin	1
22	GBAI1084-22	Root Elevator (Curved)	-	Reusable	AISI 410 Satin	Satin	1
23	GBAI1084-23	Gingivectomy Knife	-	Reusable	AISI 410 Satin	Satin	1
24	GBAI1084-24	Dental Cup / Dappen Dish	Stainless Steel	Reusable	AISI 304 Mirror	Mirror	1
25	GBAI1084-25	Dental Retractor (Minnesota Type)	-	Reusable	AISI 420 Satin	Satin	1
26	GBAI1084-26	Dental Rongeur / Bone Cutter	-	Reusable	AISI 420 Satin	Satin	1
						TOTAL QTY	26



DENTAL IMPLANT SET- (GBAI-1085)

Sr. #	Code	Instrument Description	Specification	Type	Steel Type	Finish	QTY
01	GBAI1085-01	Needle Holder	14 CM	Reusable	AISI 410 Satin	Satin	1
02	GBAI1085-02	Scissor Curved (S-Type)	14 CM	Reusable	AISI 420 Mirror	Mirror	1
03	GBAI1085-03	Scissor Straight	14 CM	Reusable	AISI 420 Mirror	Mirror	1
04	GBAI1085-04	Hemostatic Forceps	14 CM	Reusable	AISI 410 Satin	Satin	1
05	GBAI1085-05	Towel Clamp	12 CM	Reusable	AISI 410 Satin	Satin	1
06	GBAI1085-06	Cartridge Syringe / Syringe Holder	Standard	Reusable	AISI 410 Satin	Satin	1
07	GBAI1085-07	Suction Tube / Saliva Ejector	Metal	Reusable	AISI 304 Mirror	Mirror	1
08	GBAI1085-08	Bone Mixing Cup	Metal	Reusable	AISI 304 Satin	Satin	1
09	GBAI1085-09	Bone Rongeur	Standard	Reusable	AISI 410 Satin	Satin	1
10	GBAI1085-10	Bone Measuring Caliper	Standard	Reusable	AISI 410 Satin	Satin	1
11	GBAI1085-11	PR3 Periosteal Elevator	Pr3 Type	Reusable	AISI 420 Satin	Satin	1
12	GBAI1085-12	M9 Periosteal Elevator	M9 Type	Reusable	AISI 420 Satin	Satin	1
13	GBAI1085-13	Bone Separator / Elevator	Standard	Reusable	AISI 420 Satin	Satin	1
14	GBAI1085-14	Small Angled Blade	-	Reusable	AISI 420 Satin	Satin	1
15	GBAI1085-15	Buser Elevator	BUSER Type	Reusable	AISI 420 Satin	Satin	1
16	GBAI1085-16	Bone Chisel / Osteotome	Standard	Reusable	AISI 420 Satin	Satin	1
17	GBAI1085-17	Bone Curette	Standard	Reusable	AISI 410 Satin	Satin	1
18	GBAI1085-18	Tissue Elevator	Standard	Reusable	AISI 410 Satin	Satin	1
19	GBAI1085-19	Surgical Curette	Standard	Reusable	AISI 410 Satin	Satin	1
20	GBAI1085-20	Micro Elevator (Small)	Standard	Reusable	AISI 410 Satin	Satin	1
21	GBAI1085-21	Single-Sided Dental Mirror	#4	Reusable	AISI 410 Mirror	Mirror	1
22	GBAI1085-22	Double-Bent Positioning Probe	-	Reusable	AISI 410 Satin	Satin	1
23	GBAI1085-23	Tissue Forceps	12 CM	Reusable	AISI 410 Satin	Satin	1
24	GBAI1085-24	Scalpel Handle (Round Handle)	Standard	Reusable	AISI 420 Satin	Satin	1
25	GBAI1085-25	Scalpel Handle #3	#3	Reusable	AISI 420 Satin	Satin	1
26	GBAI1085-26	Silicone Tube	Irrigation Tube	Consumable	Silicone	Satin	1
						TOTAL QTY	26



ORAL SURGERY / IMPLANT SET - (GBAI-1086)

Sr. #	Code	Instrument Description	Specification	Type	Steel Type	Finish	QTY
01	GBAI1086-01	Needle Holder Mayo-Hegar	14 CM	Reusable	AISI 410	SATIN	1
02	GBAI1086-02	Artery Forceps Straight	14 CM	Reusable	AISI 410	SATIN	1
03	GBAI1086-03	Artery Forceps Curved	14 CM	Reusable	AISI 410	SATIN	1
04	GBAI1086-04	Mosquito Forceps Straight	12.5 CM	Reusable	AISI 410	SATIN	1
05	GBAI1086-05	Mosquito Forceps Curved	12.5 CM	Reusable	AISI 410	SATIN	1
06	GBAI1086-06	Towel Clamp	12 CM	Reusable	AISI 410	SATIN	1
07	GBAI1086-07	Bone Holding Forcep / Rongeur	Type A	Reusable	AISI 420	SATIN	1
08	GBAI1086-08	Periosteal Elevator (PR3 Type)	Pr3	Reusable	AISI 420	SATIN	1
09	GBAI1086-09	Periosteal Elevator (Molt Type)	Molt 9	Reusable	AISI 410	SATIN	1
10	GBAI1086-10	Periosteal Elevator (Buser Type)	Buser	Reusable	AISI 410	SATIN	1
11	GBAI1031-11	Periodontal Curette	Standard	Reusable	AISI 410	SATIN	1
12	GBAI1086-12	Periodontal Scaler	Standard	Reusable	AISI 420	SATIN	1
13	GBAI1086-13	Bone Curette Spoon	Type A	Reusable	AISI 420	SATIN	1
14	GBAI1086-14	Bone File	Double End	Reusable	AISI 420	SATIN	1
15	GBAI1086-15	Root Elevator Straight	H-Type	Reusable	AISI 410	SATIN	1
16	GBAI1086-16	Root Elevator Curved	C-Type	Reusable	AISI 410	SATIN	1
17	GBAI1086-17	Dental Mirror with Handle	#4	Reusable	AISI 410	MIRROR	1
18	GBAI1086-18	Crown / Implant Spatula	Double End	Reusable	AISI 410	SATIN	1
19	GBAI1086-19	Composite Carver	Double End	Reusable	AISI 410	SATIN	1
20	GBAI1086-20	Plugger / Condenser	Double End	Reusable	AISI 410	SATIN	1
21	GBAI1086-21	Chisel / Osteotome Straight	Standard	Reusable	AISI 410	SATIN	1
22	GBAI1086-22	Surgical Scalpel Handle	#3	Reusable	AISI 410	SATIN	1
23	GBAI1086-23	Surgical Scalpel Handle	Round Handle	Reusable	AISI 420	SATIN	1
24	GBAI1086-24	Suction Tube / Aspirating Tube	Metal	Reusable	AISI 420	SATIN	1

ORAL SURGERY / IMPLANT SET - (GBAI-1086)

Sr. #	Code	Instrument Description	Specification	Type	Steel Type	Finish	QTY
25	GBAI1086-25	Syringe Handle / Cartridge Syringe	Standard	Reusable	AISI 410	SATIN	1
26	GBAI1086-26	Measuring Caliper	Bone Gauge	Reusable	AISI 304	SATIN	1
27	GBAI1086-27	Bone Scraper / Curette	Standard	Reusable	AISI 410	SATIN	1
28	GBAI1086-28	Implant Probe / Explorer	Double End	Reusable	AISI 410	SATIN	1
29	GBAI1086-29	Periosteal Spatula	Flat/Sharp Double End	Reusable	AISI 410	SATIN	1
30	GBAI1086-30	Sterilization Surgical Cassette	Stainless Steel	Reusable	AISI 304	SATIN	1
						TOTAL QTY	30



DENTAL COMPOSITE / RESTORATIVE SET - (GBAI- 1087)

Sr. #	Code	Instrument Description	Specification	Type	Steel Type	Finish	QTY
01	GBAI1087-01	Dental Composite Spatula Double End	Standard	Reusable	AISI 410	TITANIUM BLUE COATED	1
02	GBAI1087-02	Dental Composite Carver Double End	Standard	Reusable	AISI 410	TITANIUM BLUE COATED	1
03	GBAI1087-03	Dental Plastic Filling Instrument Double End	Standard	Reusable	AISI 410	TITANIUM BLUE COATED	1
04	GBAI1087-04	Dental Condenser / Plugger Double End	Standard	Reusable	AISI 410	TITANIUM BLUE COATED	1
05	GBAI1087-05	Composite Carver (Mitra Type)	Double End	Reusable	AISI 410	TITANIUM BLUE COATED	1
06	GBAI1087-06	Composite Spatula (Spoon Type)	Double End	Reusable	AISI 410	TITANIUM BLUE COATED	1
07	GBAI1087-07	Dental Tweezers / College Tweezer	Standard	Reusable	AISI 410	TITANIUM BLUE COATED	1
08	GBAI1087-08	Sterilization Cassette (Small)	White/Orange Silicone	Reusable	AISI 304	TITANIUM BLUE COATED	1
						TOTAL QTY	8 PCS

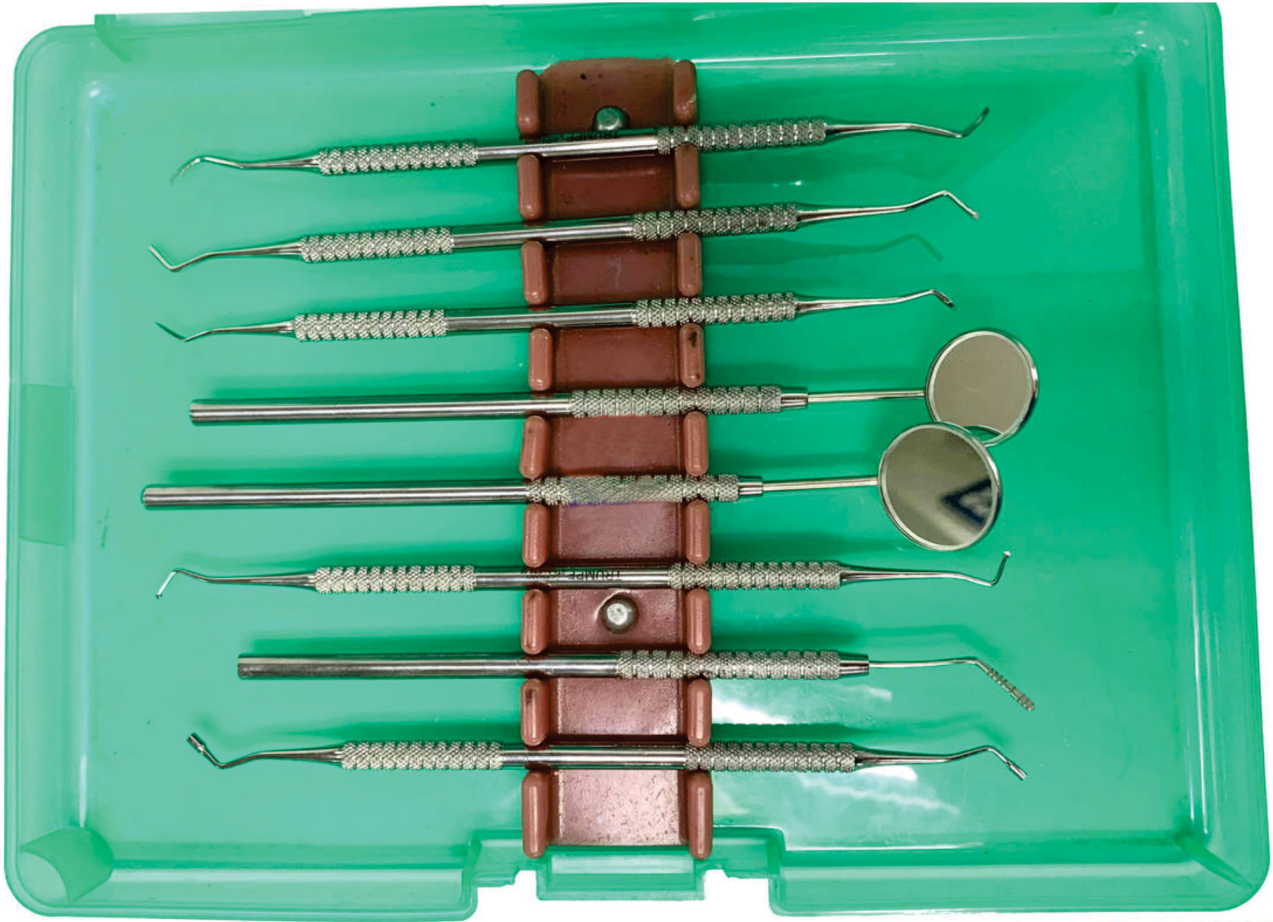

DENTAL RESTORATIVE SET - (GBAI - 1088)

Sr. #	Code	Instrument Description	Specification	Type	Steel Type	Finish	QTY
01	GBAI1088-01	Titanium Coated Composite Spatula	Double End	Reusable	AISI 410	BLACK TITANIUM	1
02	GBAI1088-02	Titanium Coated Composite Carver	Double End	Reusable	AISI 410	BLACK TITANIUM	1
03	GBAI1088-03	Titanium Coated Plastic Filling Instrument	Double End	Reusable	AISI 410	BLACK TITANIUM	1
04	GBAI1088-04	Titanium Coated Plugger / Condenser	Double End	Reusable	AISI 410	BLACK TITANIUM	1
05	GBAI1088-05	Titanium Coated Composite Sculpting Instrument	Double End	Reusable	AISI 410	BLACK TITANIUM	1
06	GBAI1088-06	Black Handle Dental Mirror	#4 Mirror	Reusable	AISI 410	BLACK TITANIUM	1
07	GBAI1088-07	Aluminium Sterilization Cassette	Blue Color	Reusable	AISI 304 Anodized Blue	ANODIZED BLUE	1
						TOTAL QTY	7 PCS



DENTAL EXAMINATION KIT - (GBAI 1089)

Sr. #	Code	Instrument Description	Specification	Type	Steel Type	Finish	QTY
01	GBAI1089-01	Gold Titanium Tweezer / College Tweezer	Standard	Reusable	AISI 410	GOLD TITANIUM OR CUSTOM	1
02	GBAI1089-02	Gold Titanium Periodontal Probe	Double End	Reusable	AISI 410	GOLD TITANIUM OR CUSTOM	1
03	GBAI1089-03	Gold Titanium Mouth Mirror with Handle	#4 Mirror	Reusable	AISI 410	GOLD TITANIUM OR CUSTOM	1
TOTAL QTY							3 PCS



ADULT DENTAL EXTRACTION FORCEP SET - (GBAI -1090)

Sr. #	Code	Instrument Description	Specification	Type	Steel Type	Finish	QTY
01	GBAI1090-01	Extraction Forceps #1 (Upper Incisors & Canines)	Standard	Reusable	AISI 420	MIRROR	1
02	GBAI1090-02	Extraction Forceps #7 (Upper Premolars)	Standard	Reusable	AISI 420	MIRROR	1
03	GBAI1090-03	Extraction Forceps #13 (Upper Molars Universal)	Standard	Reusable	AISI 420	MIRROR	1
04	GBAI1090-04	Extraction Forceps #17 (Upper Roots)	Standard	Reusable	AISI 420	MIRROR	1
05	GBAI1090-05	Extraction Forceps #17 (Lower Roots)	Standard	Reusable	AISI 420	MIRROR	1
06	GBAI1090-06	Extraction Forceps #22 (Lower Incisors & Canines)	Standard	Reusable	AISI 420	MIRROR	1
07	GBAI1090-07	Extraction Forceps #23 (Cowhorn Lower Molars)	Standard	Reusable	AISI 420	MIRROR	1
08	GBAI1090-08	Extraction Forceps #151 (Lower Universal)	Standard	Reusable	AISI 420	MIRROR	1
09	GBAI1090-09	Extraction Forceps #150 (Upper Universal)	Standard	Reusable	AISI 420	MIRROR	1
10	GBAI1090-10	Extraction Forceps #65 (Root & Crown Remnants)	Standard	Reusable	AISI 420	MIRROR	1
						TOTAL QUANTITY	10 PCS



CHILD EXTRACTION FORCEP SET - (GBAI - 1091)

Sr. #	Code	Instrument Description	Specification	Type	Steel Type	Finish	QTY
01	GBAI1091-01	Pediatric Extraction Forceps #150S (Upper Universal Small)	Small Size	Reusable	AISI 420	MIRROR	1
02	GBAI1091-02	Pediatric Extraction Forceps #151S (Lower Universal Small)	Small Size	Reusable	AISI 420	MIRROR	1
03	GBAI1091-03	Pediatric Extraction Forceps #1S (Upper Incisors & Canines)	Small Size	Reusable	AISI 420	MIRROR	1
04	GBAI1091-04	Pediatric Extraction Forceps #7S (Upper Premolars Small)	Small Size	Reusable	AISI 420	MIRROR	1
05	GBAI1091-05	Pediatric Extraction Forceps #13S (Upper Molars Small)	Small Size	Reusable	AISI 420	MIRROR	1
06	GBAI1091-06	Pediatric Extraction Forceps #22S (Lower Incisors & Canines Small)	Small Size	Reusable	AISI 420	MIRROR	1
07	GBAI1091-07	Pediatric Extraction Forceps #65S (Roots & Crown Remnants Small)	Small Size	Reusable	AISI 420	MIRROR	1
						TOTAL QTY	7 PCS



ROOT ELEVATOR SET - (GBAI - 1092)

Sr. #	Code	Instrument Description	Specification	Type	Steel Type	Finish	QTY
01	GBAI1092-01	Root Elevator Straight (Coupland Type #1)	Standard	Reusable	AISI 420	SATIN	1
02	GBAI1092-02	Root Elevator Straight (Coupland Type #2)	Standard	Reusable	AISI 420	SATIN	1
03	GBAI1092-03	Root Elevator Straight (Coupland Type #3)	Standard	Reusable	AISI 420	SATIN	1
04	GBAI1092-04	Apical Elevator Left (Winter / Cryer #R)	Left Angle	Reusable	AISI 420	SATIN	1
05	GBAI1092-05	Apical Elevator Right (Winter / Cryer #L)	Right Angle	Reusable	AISI 420	SATIN	1
06	GBAI1092-06	Root Elevator Potts / Anchorage Type	Straight Fine Point	Reusable	AISI 420	SATIN	1
07	GBAI1092-07	Root Elevator Heidbrink (H1 / H2)	Fine Root Tip Elevator	Reusable	AISI 420	SATIN	1
						TOTAL QTY	7 PCS



ORTHODONTIC SET - (GBAI - 1093)





Sr. #	Code	Instrument Description	Specification	Type	Steel Type	Finish	QTY
01	GBAI1093-01	Mathieu Needle Holder	Slim Tip	Reusable	AISI 410	SATIN	1
02	GBAI1093-02	Ligature Director	Double End	Reusable	AISI 410	SATIN	1
03	GBAI1093-03	Ligature Tucker	Standard	Reusable	AISI 410	SATIN	1
04	GBAI1093-04	Elastic Separator Placer	Blue Handle	Reusable	Aluminium + SS	SATIN	1
05	GBAI1093-05	Light Wire Plier	Standard	Reusable	AISI 420	SATIN	1
06	GBAI1093-06	Ligature Cutter	Standard	Reusable	AISI 420	SATIN	1
07	GBAI1093-07	Bracket Removing Plier (Anterior)	Standard	Reusable	AISI 420	SATIN	1
08	GBAI1093-08	Bracket Removing Plier (Posterior)	Standard	Reusable	AISI 420	SATIN	1
09	GBAI1093-09	Three-Prong Plier	Standard	Reusable	AISI 420	SATIN	1
10	GBAI1093-10	Bird Beak Plier	Standard	Reusable	AISI 420	SATIN	1
11	GBAI1093-11	Weingart Utility Plier	Slim	Reusable	AISI 420	SATIN	1
12	GBAI1093-12	Distal End Cutter	Standard	Reusable	AISI 420	SATIN	1
13	GBAI1093-13	Hard Wire Cutter	Standard	Reusable	AISI 420	SATIN	1
14	GBAI1093-14	How Utility Plier	Curved	Reusable	AISI 420	SATIN	1
15	GBAI1093-15	How Utility Plier	Straight	Reusable	AISI 420	SATIN	1
16	GBAI1093-16	Contouring Plier	Standard	Reusable	AISI 420	SATIN	1
17	GBAI1093-17	Crimping Plier	Standard	Reusable	AISI 420	SATIN	1
18	GBAI1093-18	Tweed Arch Bending Plier	Small Loop	Reusable	AISI 420	SATIN	1
19	GBAI1093-19	Loop Forming Plier	Standard	Reusable	AISI 420	SATIN	1
20	GBAI1093-20	Adhesive Removing Plier	Standard	Reusable	AISI 420	SATIN	1
21	GBAI1093-21	Adams Plier	Standard	Reusable	AISI 420	SATIN	1
22	GBAI1093-22	Elastic Ring Remover	Standard	Reusable	AISI 420	SATIN	1
23	GBAI1093-23	Banding Plier	Posterior	Reusable	AISI 420	SATIN	1
24	GBAI1093-24	Banding Plier	Anterior	Reusable	AISI 420	SATIN	1
25	GBAI1093-25	Wire Bending Plier	Heavy	Reusable	AISI 420	SATIN	1
26	GBAI1093-26	Red Instrument Case	Zip Pouch	Reusable	PU + Cloth	SATIN	1
						TOTAL QTY	26

SURGICAL INSTRUMENTS SETS CATALOGUE

China Office

-  Address: Warehouse # 406 , Building # 3, 613 Huawan Road Liwan District Guangzhou
-  Phone: +8619586483467
-  Email: ehmadmalik@gmail.com
-  Email: info@surgicalchina.com

United Kingdom Office

-  Address: Office 105 Unit 5 399-405 Oxford Street, Mayfair, London, United Kingdom, W1C 2BU
-  Phone: +442034322720
-  Phone: +447378462447
-  Email: ehmadmalik@gmail.com

Pakistan Office

-  Address: Nol Mor Wazirabad Road , Sialkot 51310 , Pakistan
-  Phone: +92 321 794 4445
-  Email: ehmadmalik@gmail.com
-  Email: info@surgicalchina.com

